

Optical Systems

Parallel-optics type (zooming type)

This system has a parallel optical path into which various intermediate tubes, including a beam splitter, coaxial episcopic illuminator, epi-fluorescence attachment, teaching head, drawing tube and eye-level riser, can be inserted.

Greenough type (zooming type)

Allows a compact body that is suited for incorporation into other devices.

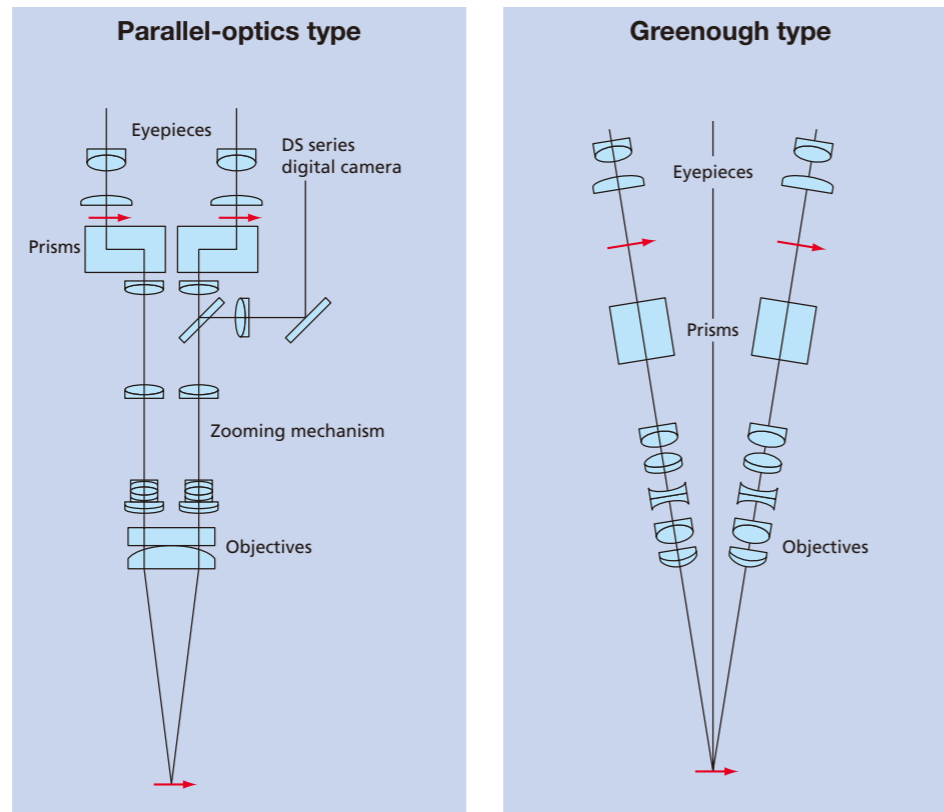

Image used in page 2 composite image courtesy of Julie C. Canman, Ph.D., Columbia University

N.B. Export of the products* in this catalog is controlled under the Japanese Foreign Exchange and Foreign Trade Law. Appropriate export procedure shall be required in case of export from Japan.

*Products: Hardware and its technical information (including software)

Specifications and equipment are subject to change without any notice or obligation on the part of the manufacturer. May 2014.

©2007-14 NIKON CORPORATION



NIKON CORPORATION

Shin-Yurakucho Bldg., 12-1, Yurakucho 1-chome, Chiyoda-ku, Tokyo 100-8331, Japan
phone: +81-3-3216-2384 fax: +81-3-3216-2388
<http://www.nikon.com/instruments/>

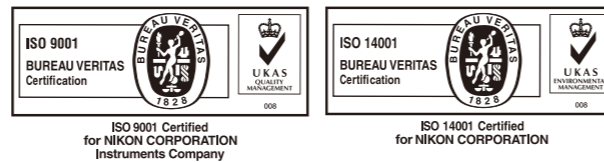

NIKON INSTRUMENTS INC.

1300 Walt Whitman Road, Melville, N.Y. 11747-3064, U.S.A.
phone: +1-631-547-8500; +1-800-52-NIKON (within the U.S.A. only)
fax: +1-631-547-0306
<http://www.nikoninstruments.com/>

NIKON METROLOGY, INC.

12701 Grand River Avenue, Brighton, MI 48116 U.S.A.
phone: +1-810-220-4360 fax: +1-810-220-4300
E-mail: Sales.US.NM@nikon.com
<http://us.nikonmetrology.com/>
<http://www.nikoninstruments.com/>

NIKON INSTRUMENTS EUROPE B.V.

Tripolis 100, Burgerweeshuispad 101, 1076 ER Amsterdam, The Netherlands
phone: +31-20-7099-000 fax: +31-20-7099-298
<http://www.nikoninstruments.eu/>

NIKON METROLOGY EUROPE NV

Geldenaaksebaan 329, 3001 Leuven, Belgium
phone: +32-16-74-01-00 fax: +32-16-74-01-03
E-mail: Sales.Europe.NM@nikon.com
<http://www.nikonmetrology.com/>

NIKON INSTRUMENTS (SHANGHAI) CO., LTD.

CHINA phone: +86-21-6841-2050 fax: +86-21-6841-2060
(Beijing branch) phone: +86-10-5831-2028 fax: +86-10-5831-2026
(Guangzhou branch) phone: +86-20-3882-0552 fax: +86-20-3882-0584

NIKON SINGAPORE PTE LTD

SINGAPORE phone: +65-6559-3618 fax: +65-6559-3668

NIKON MALAYSIA SDN BHD

MALAYSIA phone: +60-3-7809-3688 fax: +60-3-7809-3633

NIKON INSTRUMENTS KOREA CO., LTD.

KOREA phone: +82-2-2186-8400 fax: +82-2-555-4415

NIKON INDIA PRIVATE LIMITED

INDIA phone: +91-124-4688500 fax: +91-124-4688527

NIKON INSTRUMENTS S.p.A.

ITALY phone: +39-055-300-96-01 fax: +39-055-30-09-93

NIKON GMBH AUSTRIA

AUSTRIA phone: +43-1-972-6111-00 fax: +43-1-972-6111-40

NIKON UK LTD.

UNITED KINGDOM phone: +44-208-247-1717 fax: +44-208-541-4584

NIKON METROLOGY UK LTD.

UNITED KINGDOM phone: +44-1332-811-349 fax: +44-1332-639-881
E-mail: Sales.UK.NM@nikon.com

NIKON FRANCE S.A.S.

FRANCE phone: +33-1-4516-45-16 fax: +33-1-4516-45-55

NIKON METROLOGY SARL

FRANCE phone: +33-1-60-86-09-76 fax: +33-1-60-86-57-35

E-mail: Sales.France.NM@nikon.com

NIKON GMBH

GERMANY phone: +49-211-941-42-20 fax: +49-211-941-43-22

NIKON METROLOGY GMBH

GERMANY phone: +49-6023-91733-0 fax: +49-6023-91733-229

E-mail: Sales.Germany.NM@nikon.com

Stereo Microscopes



The Next Revolution in Microscopy

A Giant Step Forward in Stereo Microscopy

Nikon offers a broad range of stereo microscopes and accessories, including a research stereo microscope system with the world's highest zoom ratio, superb resolution and bright fluorescence imaging. Also features other versatile parallel-optics type models suitable for various applications and Greenough-type models that are user-friendly and affordable.

Index

Stereo Microscopes

- SMZ25, SMZ18 4
- SMZ1270/1270i, SMZ800N 8
- SMZ745/745T 12
- SMZ660, SMZ445/460 13
- SMZ-2, SM-5 14

Accessories (for SMZ25, SMZ18)

- Base Unit, Focus Unit, Stand/Focus Mount, Objective .. 15
- Tubes, Nosepiece/Focus Mount Adapter, Stage, Controller, Epi-fluorescence Set 16
- Fiber Illuminator Set, Coaxial Illuminator, Ring LED Illuminator, Darkfield Observation Accessory, Polarizing Observation Accessory 17

Accessories (for SMZ1270/1270i, SMZ800N, SMZ745/745T, SMZ660, SMZ445/460, SMZ-2, SM-5)

- Objectives, Auxiliary Objectives 18
- Nosepieces, Tubes, Eye-level Riser, Intermediate Tubes 19
- Stages, Observation Attachments 20
- Illumination Systems 21
- Stands 22
- Universal Table Stands/Focusing Mounts 23

Specifications/System Diagrams

- System Diagrams (SMZ25/18) 24
- Specifications (SMZ25/18) 25
- System Diagrams (SMZ1270/1270i/800N, SMZ745/745T) 26
- Specifications 28

Related Products

- Digital Cameras for Microscopes 30
- Digital Microscope ShuttlePix 31
- Multi-purpose Zoom Microscopes MULTIZOOM AZ100/100M 31

	SMZ25	SMZ18	SMZ1270/ 1270i	SMZ800N
Optical system	Parallel-optics type			
				
Zoom ratio	25:1	18:1	12.7:1	8:1
Zooming range	0.63-15.75x	0.75-13.5x	0.63-8x	1-8x
Total magnification*1 (with standard set*2)	3.15-945x (6.3-157.5X)	3.75-810x (7.5-135X)	3.15-480x (6.3-80X)	5-480x (10-80X)
Working distance*3	60mm	60mm	70mm	78mm
Image capture	○	○	○	○
System expandability	○	○	○	○
Embedded use	—	—	○	○

	SMZ745/ SMZ745T	SMZ660	SMZ445/ SMZ460	SMZ-2	SM-5
	Greenough type				
					
Zoom ratio	7.5:1	6.3:1	4.4:1 / 4.3:1	5:1	—
Zooming range	0.67-5x	0.8-5x	0.8-3.5x / 0.7-3x	0.8-4x	—
Total magnification*1 (with standard set*2)	3.35-300x (6.7-50X)	4-300x (8-50X)	4-70x (8-35X)/ 3.5-60x (7-30X)	4-120x (8-40X)	10-60x (20X)
Working distance*3	115mm	115mm	100mm	77.5mm	100mm
Image capture	○ (SMZ745T)	—	—	—	—
System expandability	—	—	—	—	—
Embedded use	○	○	○	○	○

*1 Depends on the combination of eyepiece and objective lens

*2 With a 10x eyepiece and a 1x objective

*3 With a 1x magnification without auxiliary objective

Research Stereo Microscope

SMZ25/SMZ18

Evolutionary stereo microscope

Nikon has developed an all-new stereo microscope that features a large zoom ratio of 25:1, high resolution and exceptional fluorescence transmission capability. The new stereo microscope meets the increasing needs for imaging systems that span spatial scales from single cells to whole organisms.

World's widest zoom range and highest resolution for a stereo microscope

- First stereo microscope to offer a 25:1 zoom range (SMZ25)
- Both eye paths boast numerical apertures (NA) of up to 0.156, using the SHR Plan Apo 1x objective and SMZ25

Automation and digital imaging

- Motorized focus and zoom operation (SMZ25)
- Imaging Software NIS-Elements enables the use of multiple imaging, processing and analysis modalities, including z-stack capture, time-lapse imaging and EDF image generation



SMZ25 Motorized zoom model with the highest zoom ratio and resolution in the SMZ series

Bright, high-contrast fluorescent images

- Fly-eye lens ensures uniform brightness over the entire field of view even at the lowest magnifications
- Breakthroughs in optical design mean significantly improved signal to noise ratio and crystal clear fluorescent images

Easy to use

- User-friendly remote control (SMZ25)
- Easy-to-operate slim LED DIA base with OCC illumination
- Wide range of illuminators and accessories that accommodate a variety of observation methods



SMZ18 Manual zoom model providing advanced optical performance and incredibly bright fluorescence at an attractive price

Model	SMZ25	SMZ18
Type	Motorized zoom	Manual zoom
Observation	Brightfield/Darkfield/Fluorescence/Simple polarizing	
Zoom ratio	25:1	18:1
Magnification range	0.63x - 15.75x	0.75x - 13.5x (with 0.75/1/2/3/4/5/6/8/10/12/13.5x click stops)
Maximum magnification	315x ^{*1}	270x ^{*1}
Maximum FOV	ø70 mm ^{*2}	ø59 mm ^{*2}
Maximum NA of	0.312 ^{*3}	0.3 ^{*3}

*1: Using SHR Plan Apo 2x/ C-W10xB *2: Using SHR Plan Apo 0.5x/ C-W10xB *3: Using SHR Plan Apo 2x

Remarkable resolution and the world's widest zoom range

Dynamic zoom ratio of 25:1 **SMZ25**

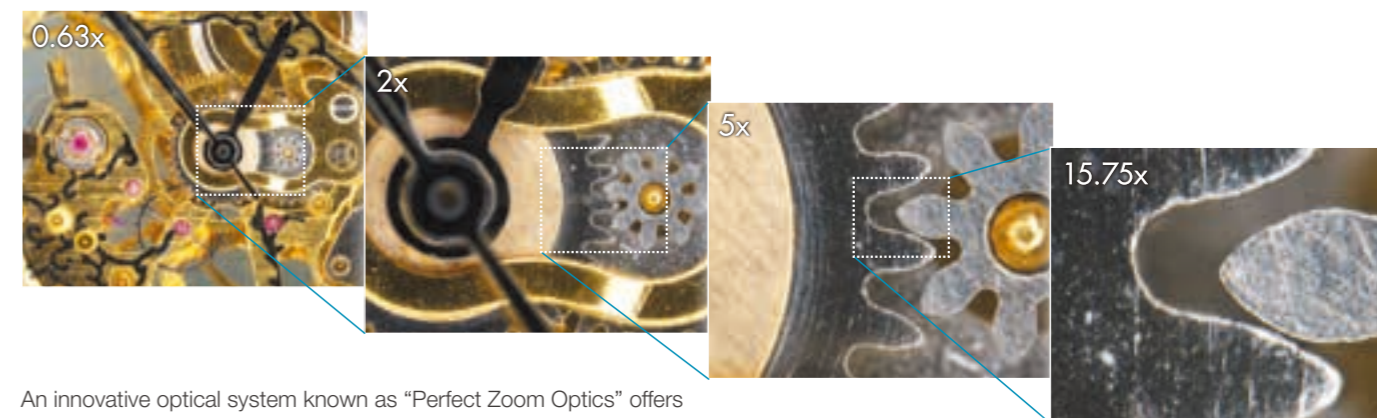

An innovative optical system known as "Perfect Zoom Optics" offers the world's first zoom ratio of 25:1 (zoom range: 0.63x - 15.75x*; *as of May 2013). The SMZ25 can seamlessly capture the entire dish while simultaneously delivering microscopic details.

Auto Link Zoom (ALZ) supports seamless viewing at different scales **SMZ25**

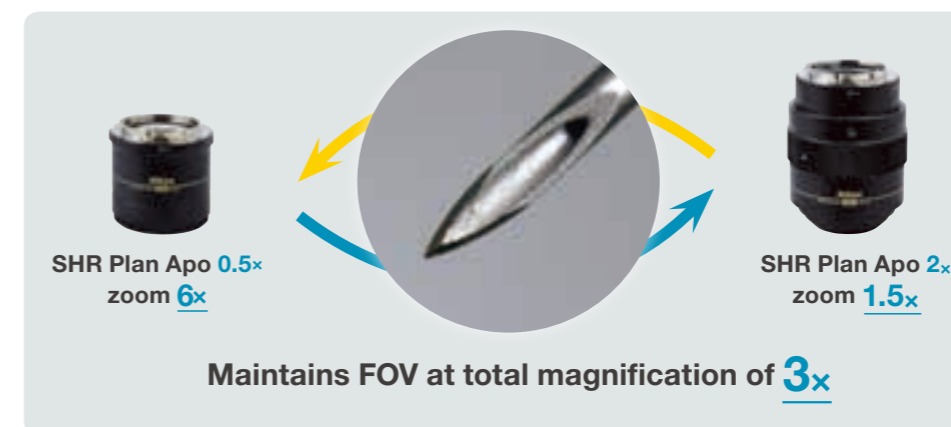

ALZ automatically adjusts the zoom factor to maintain the same field of view when switching objective lenses. This function enables seamless switching between whole organism imaging at low magnifications and detailed imaging at high magnifications.

Superior resolution never before seen on a stereo microscope **SMZ25** **SMZ18**

Newly developed SHR (Super High Resolution) Plan Apo series objective offers a resolution of 1100LP/mm (observed value, using SHR Plan Apo 2x at maximum zoom). The 0.5x, 1x, or 1.6x lower magnification objectives deliver a bright field of view and brilliant images with true-to-life colors.



Comparison of resolution and color aberration by resolution chart

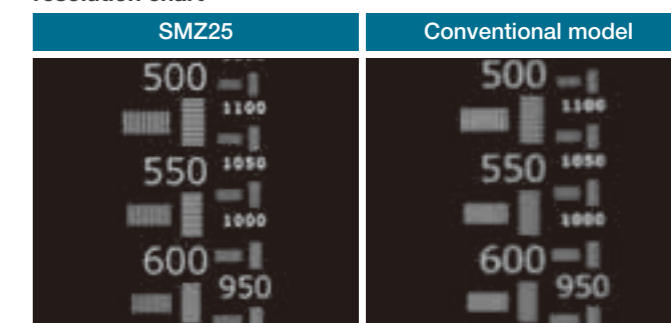

Parallel-optics type

Bright, high-contrast fluorescent images SMZ25 SMZ18

Enhanced brightness and uniform illumination in a low magnification range

The SMZ25 series is the first stereo microscope in the world to use a fly-eye lens on an epi-fluorescence attachment. This ensures bright, uniform illumination even at low magnifications across a large field of view.

Improved S/N ratio and crystal clear fluorescent images thanks to an improved optical system

Nikon has succeeded in improving the signal and reducing noise in fluorescent images by using a short-wavelength, high-transmission Fluor lens. This enables observations of cell division and samples with weak fluorescence, both of which are difficult using conventional stereo microscopes.

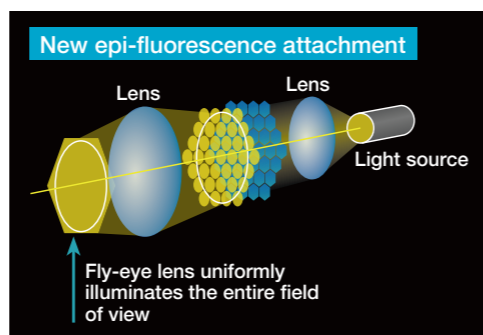

Sample images

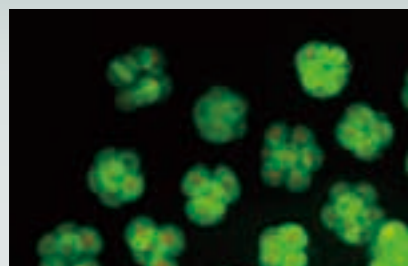

Fertilized mouse egg
Image courtesy of Kazuo Yamagata, Ph.D., Center for Genetic Analysis of Biological Responses, Research Institute for Microbial Diseases, Osaka University

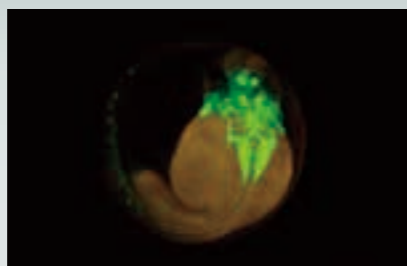

2 days old Transgenic Zebrafish embryo, Tg (isl1-GFP)
(using SHR Plan Apo 1x at zoom magnification of 6x with SMZ25)
Image courtesy of Hisaya Kakinuma, Ph.D., Laboratory for Developmental Gene Regulation, Developmental Brain Science Group, RIKEN Brain Science Institute



Board

Automation and digital imaging SMZ25 SMZ18

A wide range of digital imaging capabilities with the Digital Sight series and NIS-Elements imaging software

Easily obtain the information required, such as Z drive position, zoom factor, objective lens, filter cube and LED DIA brightness, by using the Digital Sight series and NIS-Elements or Digital Sight series DS-L3 together with the microscope.



Detected observation condition/available control ○ : Detection and control of observation condition possible ○ : Detection of observation condition possible

	SMZ25		SMZ18	
	DS-L3	NIS-Elements	DS-L3	NIS-Elements
	<ul style="list-style-type: none"> Motorized focus unit Motorized epi-fluorescence set (control box A) 		<ul style="list-style-type: none"> Manual focus unit Manual epi-fluorescence set (relay box and control box B) 	
Zoom magnification	○	○	○	○
Focusing	○	○	—	—
Objective (with nosepiece)	○	○	○	○
Diascopic LED illumination stand (ON/OFF, light intensity control)	○	○	○	○
Fluorescence illuminator (light intensity control)	○	○	○	○
Filter cube	○	○	○	○

For other combinations, please confirm with Nikon.

* With NIS-Elements F (Free package), functions above are not available. Use NIS-Elements D/Br/Ar.

Improved observation efficiency

Easy-to-use OCC illumination SMZ25 SMZ18

The new LED DIA Base with built-in OCC illuminator generates minimal heat, consumes little power and has a long life. The illuminator also enhances the contrast of uneven surfaces, such as those of film.



The OCC illuminator can be controlled using a slide lever. Thanks to scales on the slide lever, the user can save and reproduce desired illumination levels. In addition, an OCC plate can be inserted into the illumination unit from the front and rear sides, so images with different shadow direction can be observed.

Comparison images (film)

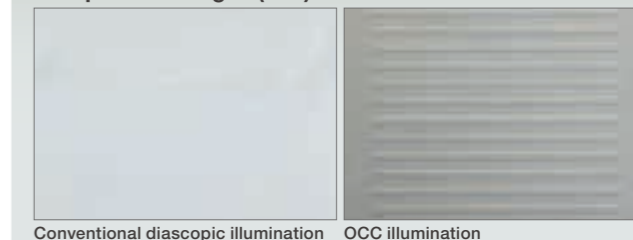

Conventional diascopic illumination OCC illumination

What is OCC illumination?

OCC stands for oblique coherent contrast, a form of oblique lighting method developed by Nikon. Compared to conventional diascopic illumination that illuminates directly from below, OCC illumination applies coherent light to samples in a diagonal direction, adding contrast to colorless and transparent sample structures.

User-friendly remote control SMZ25

The all-new remote control provides easy access to zoom and focus controls and is designed for both right- and left-hand use. The remote control contains an LCD monitor with an adjustable backlight that provides at-a-glance information about zoom factor, objective lens, filter cube and LED DIA brightness.



On-axis imaging for digital images SMZ25 SMZ18

Easily switch between stereo position (stereoscopic view) and mono position (on-axis view) when using the P2-RNI2 Intelligent Nosepiece by simply moving the objective lens.

Comparison of on-axis image and stereoscopic image

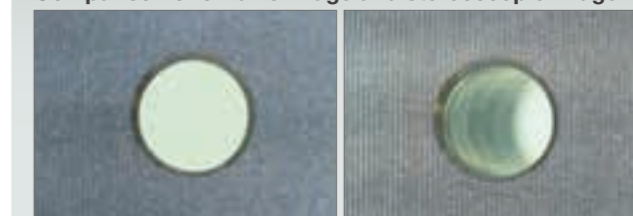

On-axis image Stereoscopic image

Parallel-optics type

Stereo Microscope

SMZ1270/1270i SMZ800N



Incredible sharpness throughout a wide magnification range

These versatile stereo microscopes provide both excellent optical performance, such as high-magnification, high-zoom ratio and high-resolution images, and advanced operability. The expandability of parallel optics makes these models suitable for a wide range of applications.

Highest-in-class zoom ratio

- Highest-in-class zoom ratio of 12.7:1 (0.63 – 8x) with SMZ1270/1270i
- New WF series objectives optimized for wide viewfield observation at low magnification

High-quality images

- High-level chromatic aberration correction provides sharp images throughout the viewfield.

Easy to get results

- Automatically detects magnification data in combination with the digital camera control unit (SMZ1270i only)
- Nosepiece offers both widened magnification range and on-axis imaging
- Eyepiece tubes with various inclination angles and slim-type stands minimize user fatigue during observation

Expandable with a wide range of accessories

- A wide range of accessories are available, including eyepiece tubes and stands that are equal to superior specification stereo microscope models



SMZ1270

Versatile stereo microscope with the highest-in-class zoom ratio



SMZ1270i

The same as the SMZ1270 but equipped with intelligent functions found in superior models (SMZ1270i with a trinocular tilting tube and nosepiece)



SMZ800N

Affordable model with improved operability and basic performance

Highest-in-class zoom ratio

Wide zoom range

The SMZ1270/1270i offers the highest-in-class zoom ratio of 12.7x (0.63 – 8x). It offers both low-magnification wide viewfield observation of the whole of a 35 mm petri dish* during screening and high-magnification observation of minute cell structures



SMZ1270/1270i enables observation of the whole of a 35 mm petri dish.

* with 1x objective at the lowest magnification.

Wide viewfield of SMZ1270/1270i

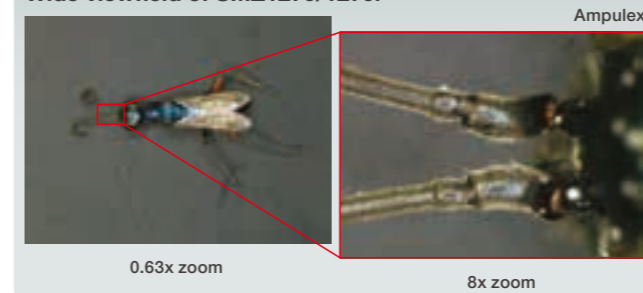

Ampulex

0.63x zoom

8x zoom

The SMZ800N comes with a 1 – 8x zoom range, with higher magnification than conventional models and enables high-resolution observation of 640LP/mm (using ED Plan Apo 2x/WF at maximum zoom).

Improved resolution of SMZ800N



SMZ800N

Conventional model

Newly developed objectives

The newly developed WF series objectives offer uniformly bright images even at low magnification and wide viewfield observation with SMZ1270/1270i. In addition, a 0.75x objective is now available, expanding the lineup of low magnification objectives.



High-quality images

Apochromat optics have been adopted for the lenses in the SMZ1270/1270i zoom body and semi-apochromat optics in the SMZ800N to achieve high-level chromatic aberration correction. They provide sharp images without blur or color fringe.



Apochromat optics (captured with SMZ1270+Plan Apo 1x/WF)

Conventional optics

Easy to get results

Intelligent function for status readout SMZ1270i

In combination with the Camera Control Unit DS-L3 and imaging software NIS-Elements, the SMZ1270i can detect zoom magnification data. In addition, with the Intelligent Nosepiece P-RNI2 attached, data related to the objective in use is also detected. Calibration data is automatically altered, following changes of magnification, to display the appropriate scale and measurement results on the images.

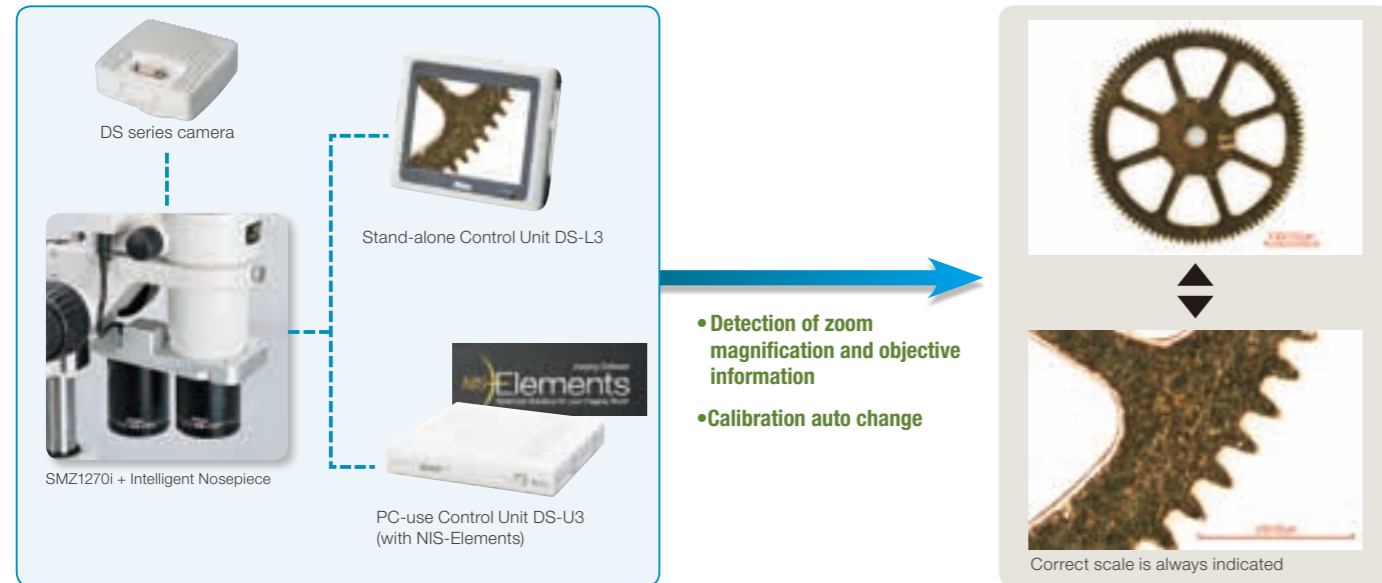

On-axis observation with the nosepiece

The double nosepiece offers easy on-axis imaging, enabling observation of the bottom of holes, accurate simple measurement and extended depth of focus (EDF) imaging without distortion.



Ergonomic design

Eyepiece tubes with a range of inclination angles are available for comfortable observation. They offer the optimum eyelevel to suit each user. In addition, slim-type plain stands and the LED Diascopic Illumination Stand easily facilitate the presentation and removal of specimens.

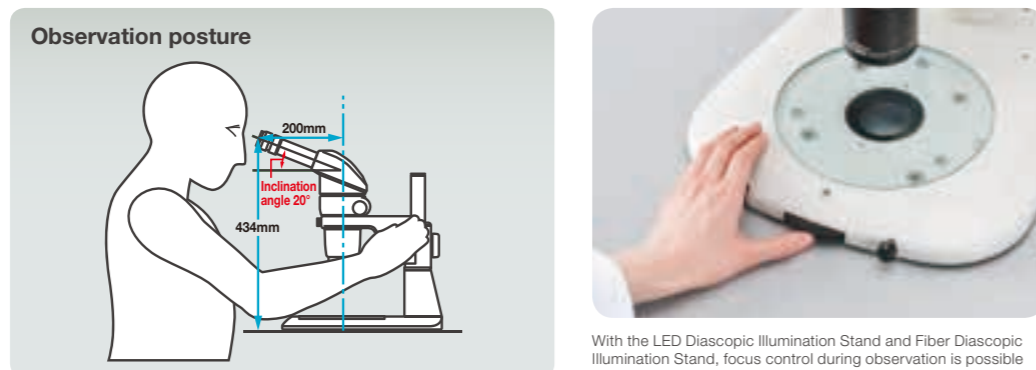

Expandable with a wide range of accessories

In addition to conventional accessories, the level of accessories used with superior models is also available for the SMZ1270/1270i and SMZ800N. These include trinocular tubes and slim-type LED diascopic illumination stands. These allow various microscope configurations to suit numerous routine inspections and a range of research and development applications.

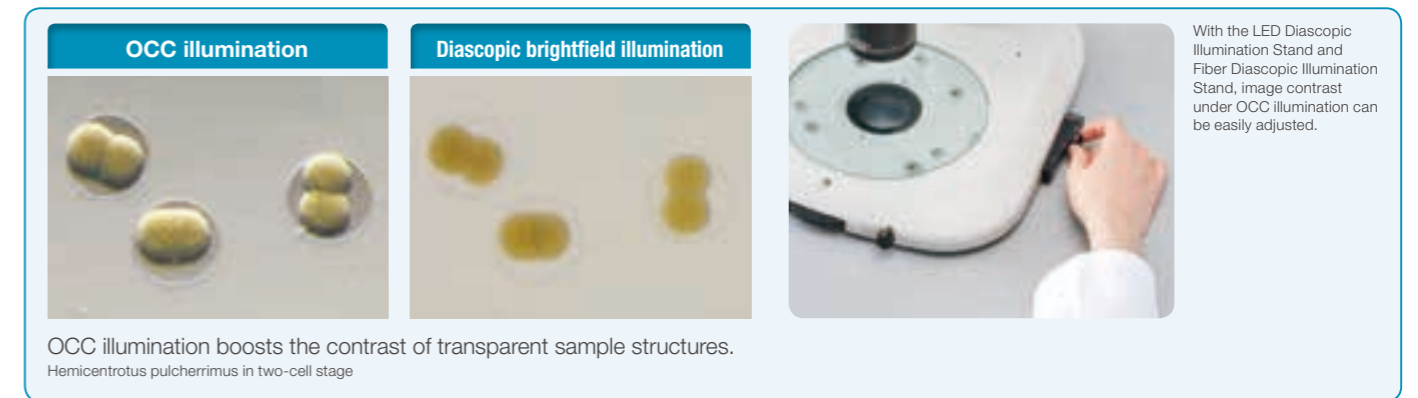
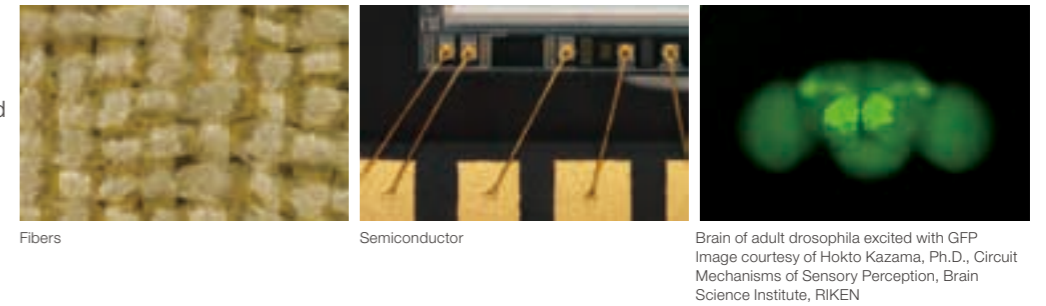

	SMZ1270	SMZ1270i	SMZ800N
Optical system	Parallel-optics type (zooming type)		
Zoom ratio	12.7 : 1		8 : 1
Zoom range	0.63 – 8x (0.63/1/2/3/4/6/8x stops)		1 – 8x (1/2/3/4/6/8x stops)
Total magnification	3.15 – 480x (depending on eyepiece and objectives) (with coaxial episcopic illuminator: 15 – 540x)		5 – 480x (depending on eyepiece and objectives) (coaxial episcopic illuminator: 22.5 – 540x)
Tubes	Eyepiece inclination: 20° (P-B Binocular Tube) / 15° (P-TL100 Trinocular Tube) / 0°-30° (P-TERG100 Trinocular Tilting Tube, P-TERG50 Trinocular Tilting Tube)		
Eyepieces	C-W10xB (F.N. 22), C-W15x (F.N. 16), C-W20x (F.N. 12.5), C-W30x (F.N. 7)		
Objectives	Plan Apo 0.5x/WF, Plan Apo 0.75x/WF, Plan Apo 1x/WF, ED Plan 1.5x/WF, ED Plan 2x/WF		Plan Apo 0.5x/WF, Plan Apo 0.75x/WF, Plan Apo 1x/WF, ED Plan 1.5x/WF, ED Plan 2x/WF, Plan 1x, ED Plan 0.75x, Achrom 0.5x
Working distance	70 mm (with Plan Apo 1x/WF)		78mm (with Plan 1x)
Weight (approx.)	9.8 kg (with P-B Binocular Tube + P-DSL32 LED Diascopic Illumination Stand)	11.9 kg (with P-TERG100 Trinocular Tilting Tube + P-DSL32 LED Diascopic Illumination Stand)	6.8 kg (with P-B Binocular Tube + C-PSN Plain Stand)

Please refer to the system diagram (P. 26-27) for accessory combinations.

Dimensions

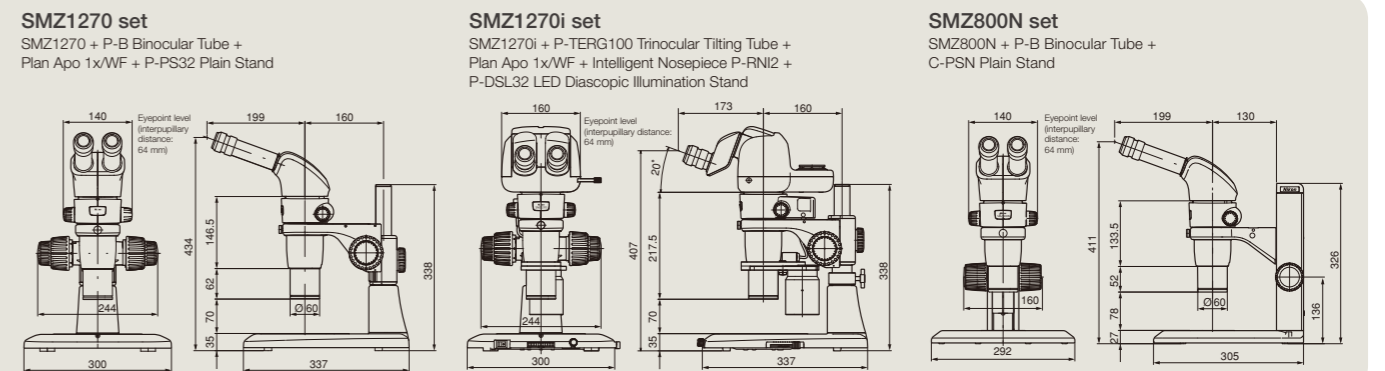

Greenough Type Stereo Microscope

SMZ745/745T

Superior 7.5x zoom and 115 mm working distance
Trinocular optical head type is also available

- The SMZ745/745T boasts a 7.5x zoom that incorporates the Greenough optical system. The zoom range of 0.67x to 5x provides a broad observation range.
- As well as high zoom ratio and magnification, the SMZ745/745T offers an unrivaled 115 mm working distance.
- The SMZ745T incorporates an optical path switching lever that enables easy switchover between eyepiece and camera. A DS series digital camera can be attached.



Three "A" design

- Air-tight **SMZ745** **SMZ660**

By making joints airtight, contamination from dust, oil, water and other contaminants is prevented.

Airtight construction: JIS Degrees of protection provided by enclosures IPX1

- Anti-mold **SMZ745** **SMZ745T** **SMZ660**

Anti-mold design developed exclusively by Nikon ensures peace of mind when the microscope is used in environments subject to high heat or humidity.

- Anti-electrostatic **SMZ745** **SMZ745T** **SMZ660**

Static electricity built up within the microscope is discharged almost instantly, ensuring higher yields.

Antistatic function: 1000–10V, discharge within 0.2 sec.

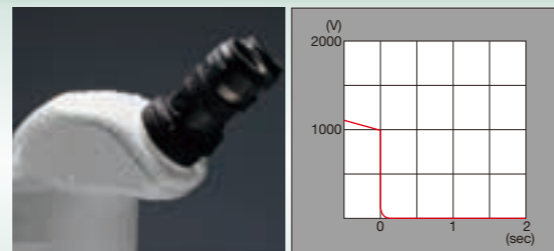

Specifications

	SMZ745	SMZ745T
Optical system	Greenough type (zooming type)	Greenough type (zooming type), trinocular tube
Zoom ratio	7.5 : 1	
Zoom range	0.67-5x (with 0.67/1/2/3/4/5x stops)	
Total magnification	3.35-300x (depending on eyepiece and auxiliary objective used)	
Straight tube	—	Built-in C-mount 0.55x magnification lens (F.N. 11), compatible with 2/3 in. or smaller CCD
Tubes	Fixed type Eyepiece inclination: 45° Interpupillary distance adjustment: 52-75 mm	
Eyepieces (with diopter adjustment)	C-W 10xB (F.N. 22), C-W 15x (F.N. 16), C-W 20x (F.N. 12.5), C-W 30x (F.N. 7)	
Auxiliary objectives	G-AL 0.5x (W.D. 211 mm), G-AL 0.7x (W.D. 150 mm), G-AL 1.5x (W.D. 61 mm), G-AL 2x (W.D. 43.5 mm), G-AL ERG 0.77-1.06x (W.D. 102-48mm)	
Working distance	115 mm (standard)	
Airtight construction	JIS Degrees of protection provided by enclosures IPX1	
Weight (approx.)	1.6 kg (body)	1.8 kg (body)

F.N.: Field Number

Dimensions

SMZ745 set SMZ745 + C-PSN Plain Stand/CN

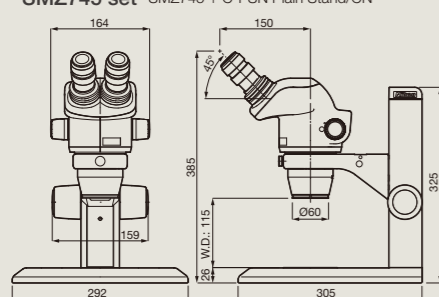

SMZ745T set SMZ745T + C-PSN Plain Stand/CN

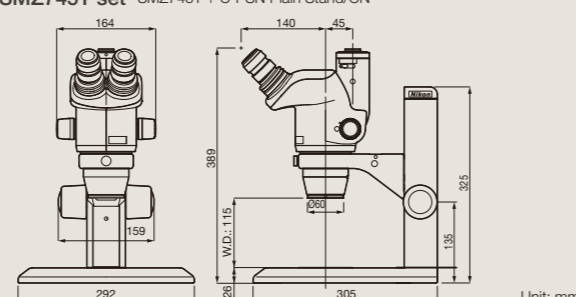

Unit: mm

Greenough Type Stereo Microscope

SMZ660

Dramatically improved optical performance and handling comfort

- 6.3x zoom ratio offers magnifications of 0.8x to 5x. The zooming knob features click-stops that allow changes in magnification of 1x increments.
- Even at high magnification, a working distance of 115mm, the longest in this microscope class, is realized.
- Three "A" design



Specifications

	SMZ660
Optical system	Greenough type (zooming type)
Zoom ratio	6.3 : 1
Zoom range	0.8-5x (with 0.8/1/2/3/4/5x stops)
Total magnification	4-300x (Depending on eyepiece and auxiliary objective used.)
Tube	Eyepiece inclination: 60° Interpupillary distance adjustment: 52-75 mm
Eyepieces (with diopter adjustment)	C-W10xB (F.N. 22), C-W15x (F.N. 16), C-W20x (F.N. 12.5), C-W30x (F.N. 7)
Auxiliary objectives	G-AL 0.5x (W.D. 211 mm), 0.7x (W.D. 150 mm), 1.5x (W.D. 61 mm), 2x (W.D. 43.5 mm) G-AL ERG 0.77-1.06x (W.D. 102-48 mm)
Working distance	115 mm (with standard configuration)
Airtight construction	JIS Degrees of protection provided by enclosures IPX1
Weight (approx.)	1.6 kg (body)

Dimensions

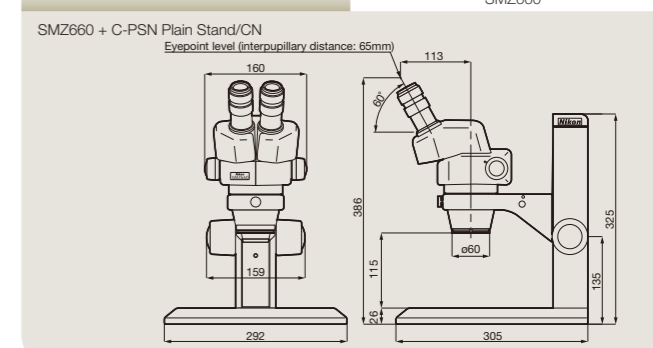

Greenough Type Stereo Microscope

SMZ445/460

Designed for excellent cost performance

- The SMZ445 has a 45° eyepiece tube inclination, and the SMZ460 has a 60° eyepiece tube inclination, which is ideal for embedded use.
- Compact design with ease-of-use and high optical performance.
- ESD protection guards against electrostatic damage to samples.



Specifications

	SMZ445	SMZ460
Optical system	Greenough type (zooming type)	
Zooming ratio	4.4 : 1	4.3 : 1
Zooming range	0.8-3.5x	0.7-3x
Total magnification	4-70x	3.5-60x
Tube	Eyepiece inclination: 45° Interpupillary distance adjustment: 54-75 mm Eyepiece diopter adjustable for both eyes	Eyepiece inclination: 60° Interpupillary distance adjustment: 54-75 mm Eyepiece diopter adjustable for both eyes
Eyepieces	SM 10xB (F.N. 21), SM 15xB (F.N. 14), SM 20xB (F.N. 12)	
Auxiliary objectives (option)	AL5 (0.5x), AL7 (0.7x)	
Working distance	100 mm (standard)	
Weight (approx.)	1.0 kg (body)	1.1 kg (body)

Dimensions

SMZ445 SMZ445 + C-PSN Compact Stand/CN

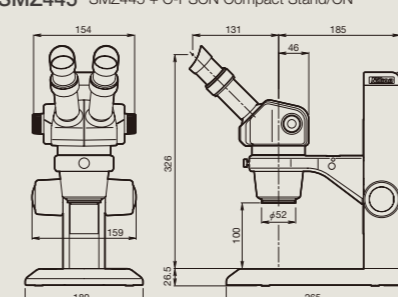

SMZ460 SMZ460 + C-FMBN Focusing Mount BN

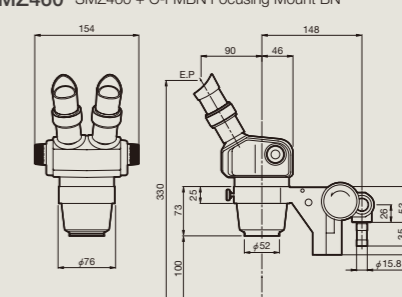

Unit: mm

Greenough Type Stereo Microscope

SMZ-2

High-resolution optics ideal for inspection, assembly, and measurement

- Compact design with horizontally positioned zooming ring (rotation: 90°)
- Eyepiece inclination of 45° for comfortable observation



SMZ-2 (Clemmer is optional)

Specifications	
	SMZ-2
Optical system	Greenough type (zooming type)
Zooming ratio	5 : 1
Zooming range	0.8–4x
Total magnification	4–120x (Depending on eyepiece and auxiliary objective used.)
Tube	Eyepiece inclination: 45° Interpupillary distance adjustment: 56–75 mm
Eyepieces (with diopter adjustment)	SM E10xA (F.N. 23, standard), SM E15xA (F.N. 14), SM 20xB (F.N. 12), C-W30x (F.N. 7)
Auxiliary objectives	AL5 (0.5x), AL7 (0.7x)
Working distance	77.5 mm (with standard configuration)
Weight (approx.)	1.6 kg (body), 1.9 kg (stand)

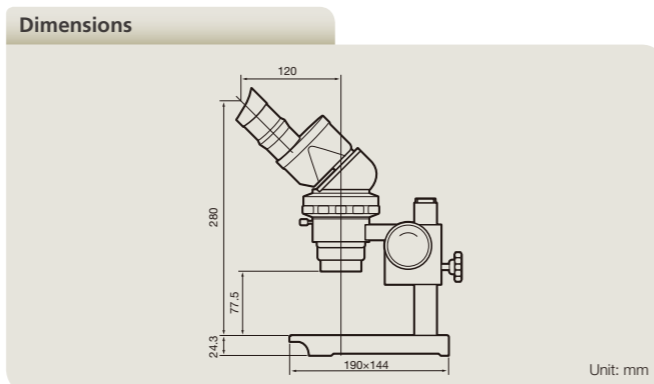

Greenough Type Stereo Microscope

SM-5

Standard stereo microscope with fixed objective magnification

- Objective has fixed magnification of 2x. Total magnification ranges from 10x to 60x depending on eyepiece and auxiliary objective used.



SM-5 (Clemmer is optional)

Specifications	
	SM-5
Optical system	Greenough type (fixed type)
Objectives	2x
Total magnification	10x–60x (Depending on the eyepiece and auxiliary objective used.)
Tube	Eyepiece inclination: 45° Interpupillary distance adjustment: 56–75 mm
Eyepieces	SM E10xA (F.N. 23, standard), SM E15xA (F.N. 14), SM 20xB (F.N. 12), C-W30x (F.N. 7)
Auxiliary objectives	AL5 (0.5x), AL7 (0.7x)
Working distance	100 mm (standard)
Weight (approx.)	0.9 kg (body), 1.9 kg (stand)

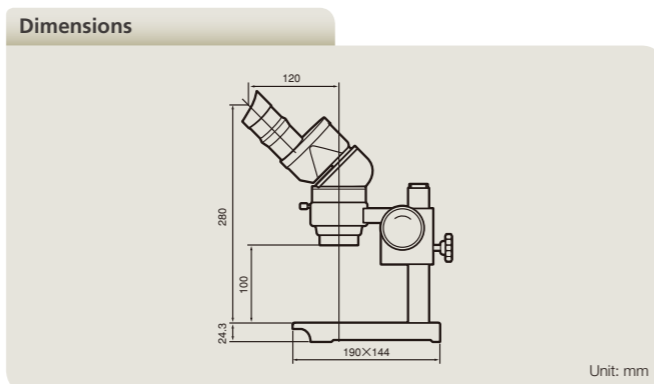

Wide range of dedicated accessories for SMZ25/SMZ18 for all types of observation

Base Unit, Focus Unit, Stand/Focus Mount

Base Unit

Nikon has improved ease of use by moving the controls to the front of the base, including the brightness adjustment dial and the on/off switch.

Fiber DIA base

The Fiber DIA base features condenser lenses that can be switched between low and high magnifications. Furthermore, the OCC illumination system allows high-contrast illumination.



1 P2-DBF Fiber Diascopic Illumination Base

Slim Bases

The slimmer LED DIA Base and Plain Base help increase efficiency of sample manipulation by bringing the level of the sample closer to the table.



2 P2-DBL LED Diascopic Illumination Base

3 P2-PB Plain Base

Focus Unit

The focus unit is combined with the base unit. Choose from either a manual or motorized focus unit.



1 P2-MFU Motorized Focus Unit

2 P2-FU Focus Unit

Stand/Focus Mount

SMZ18 can be mounted on various compact stands using a focus mount.



1 P2-FMDN Focus Mount
2 P-PS32 Plain Stand

4 P-DSF32 Fiber Diascopic Illumination Stand

3 P-DSL32 LED Diascopic Illumination Stand

SHR Plan Apo Objective Series

The SHR Plan Apo series features higher NA, wider field of view and superior flatness and color aberration correction. These objective lenses can be seamlessly switched because all magnifications have the same parfocal distance. The new bayonet mount design allows lenses to be safely and easily removed.



1 P2-SHR Plan Apo 0.5x
3 P2-SHR Plan Apo 1.6x

2 P2-SHR Plan Apo 1x
4 P2-SHR Plan Apo 2x

		SHR Plan Apo 0.5x	SHR Plan Apo 1x	SHR Plan Apo 1.6x	SHR Plan Apo 2x
Maximum NA	SMZ25	0.078	0.156	0.25	0.321
	SMZ18	0.075	0.15	0.24	0.3
Working distance		71 mm	60 mm	30 mm	20 mm
Correction ring		—	—	—	3 mm water depth
Wavelength		380-700 nm			

Tubes

Choose from two types of tilting trinocular tube and one type of low eyelevel trinocular tube. All tubes have a camera port for seamless integration with the Digital Sight series.



- 1 P2-TERG100 Trinocular Tilting Tube (eyepiece: port 100:0 / 0:100)
- 2 P2-TERG50 Trinocular Tilting Tube (eyepiece: port 100:0/50:50)
- 3 P2-TL100 Trinocular Tube L (eyepiece: port 100:0 / 0:100)

Nosepiece/Focus Mount Adapter

Both single and double nosepieces are available.



- 1 P2-FNI2 Intelligent Nosepiece
- 2 P2-FM Focus Mount Adapter

Stage

The stage features an XY stroke of 6x4 inches (150 mm x 100 mm) and can be attached to any of the bases, making it effective for capturing large images when used in combination with imaging software NIS-Elements. A sliding stage and tilting stage are also available.

*Limited Y travel with 32 mm column bases

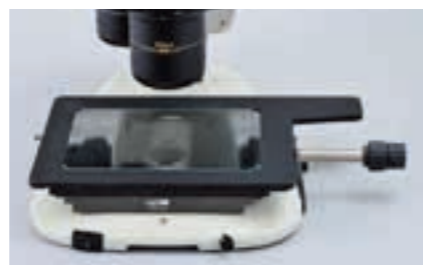

P-SXY XY Stage

Remote Control

Nikon offers a remote control unit that can be used to operate the microscope and capture images by hand. A footswitch is also available, allowing the user to operate the microscope and capture images by foot, freeing the hands for sample manipulation.



P2-RC Remote Controller

- 1 AZ-PCR Photo Release
- 2 AZ-FSW Foot Switch

Darkfield Observation Accessory

Darkfield viewing is possible simply by attaching the darkfield unit to the base.

- 1 P-DF LED Dark Field Unit
- 2 Shading cover



Polarizing Observation Accessory

The analyzer is attached to the objective and the polarizer to the base or stand to enable polarized viewing.

- 1 P2-POL Simple Polarizing Attachment



Epi-fluorescence Set

Motorized Epi-fluorescence Set

The fluorescent turret can be operated using the remote control or imaging software NIS-Elements.



- 1 P2-EFLM Motorized Epi Fluorescence Attachment
- 2 Light shading Plate (comes with Fluorescence Attachment)
- 3 P2-EFL Filter Cube (GFP-B/GFP-L/RFP)
- 4 P2-EFLBF Filter Cube (Bright Field)
- 5 P2-CTLA Control Box
- 6 P2-RC Remote Controller
- 7 P2-CIA QL1x/0.5x 1/4 λ Plate

Combinations with SMZ25

Fiber Illuminator Set

Flexible Double Arm Fiber Illumination Set

The direction and angle of illumination can be changed to suit the sample by making adjustments with these double arms. The fiber holder position can also be changed to obtain the optimal position for illuminating samples.

- 1 C-FDF Flexible Double Arm Fiber Illumination Unit
- 2 C-FIDH Fiber Holder
- 3 C-FLED2 LED Light Source for Fiber Illuminator



Combinations with SMZ18

Manual Epi-fluorescence Set

An easy-to-use manual model for Nikon's newly developed high-performance epi-fluorescence attachment.



- 1 P2-EFLI Epi Fluorescence Attachment
- 2 Light shading Plate (comes with Fluorescence Attachment)
- 3 P2-EFL Filter Cube (GFP-B/GFP-L/RFP)
- 4 P2-EFLBF Filter Cube (Bright Field)
- 5 P2-CTLB Control Box
- 6 P2-CIA QL1x/0.5x 1/4 λ Plate

Combinations with SMZ18

Ring Fiber Illumination Set

This ring fiber illumination set features an episcopic illumination unit that effectively captures images (can be used with 1x and 0.5x objective lenses).

- 1 P2-FIR Ring Fiber Illumination Unit
- 2 C-FLED2 LED Light Source for Fiber Illuminator



Combinations with SMZ18

Coaxial Illuminator

The coaxial light illuminator makes it possible to view light reflected from the surface of a sample. It is ideal for shooting shadow-less images of thick samples.

- 1 P2-CI Coaxial Epi Illuminator
- 2 C-FLED2 LED Light Source for Fiber Illuminator
- 3 P2-CIA QL1x/0.5x 1/4 λ Plate



Combinations with SMZ18

Ring LED Illuminator

Ring LED illuminator is equipped with high-intensity, long-life (20,000 hours) LEDs. The illuminator's dial adjusts the intensity of the white LED.

- 1 P2-FIRL LED Ring Illumination Unit



Combinations with SMZ25

A variety of accessories are available for stereoscopic observations



Plan Apo WF series

Objectives

A wide selection with various magnifications and working distances is available, including high-NA, high-resolution and wide-viewfield Plan Apo WF series objectives with superior image flatness and chromatic aberration correction.

SMZ1270/1270i SMZ800N



- 1 Plan Apo 0.5x/WF
- 2 Plan Apo 0.75x/WF
- 3 Plan Apo 1x/WF
- 4 ED Plan 1.5x/WF
- 5 ED Plan 2x/WF

Objectives	Working distance (mm)	Zoom magnification	NA	Actual FOV*1
Plan Apo	0.5x/WF	0.63x	0.0095	69.8
	0.75x/WF	8x	0.0525	5.5
	1x/WF	0.63x	0.0143	46.6
ED Plan	1.5x/WF	8x	0.0788	3.7
		8x	0.1050	2.75
	2x/WF	0.63x	0.0190	2.6
		8x	0.0285	23.3
		8x	0.1575	1.8
		0.63x	0.0380	17.5
		8x	0.2100	1.4

*1 With C-W10xB eyepiece

SMZ800N



- 1 Achro 0.5x
- 2 ED Plan 0.75x
- 3 Plan 1x

Objectives	Working distance (mm)	Zoom magnification	NA	Actual FOV*1	
Achro	0.5x	189	1x	0.0145	44
			8x	0.0525	5.5
ED Plan	0.75x	117	1x	0.0218	29.3
			8x	0.0788	3.7
Plan	1x	78	1x	0.0290	22
			8x	0.1050	2.75

*1 With C-W10xB eyepiece

Auxiliary Objectives

Microscopes	Auxiliary objectives	Working distance (mm)
SMZ745/745T SMZ660	G-AL ERG 0.77-1.06x	102-48
	G-AL 0.5x	211
	G-AL 0.7x	150
	G-AL 1.5x	61
	G-AL 2x	43.5

Microscopes	Auxiliary objectives	Working distance (mm)
SMZ445/460	AL5 (0.5x)	181
	AL7 (0.7x)	127.5
SMZ-2	AL5 (0.5x)	103
	AL7 (0.7x)	95
SM-5	AL5 (0.5x)	175
	AL7 (0.7x)	128

Nosepieces

Double nosepiece with two-objective switchover. Easy changeover from stereo position (stereoscopic view) to mono position (on-axis view) is possible by simply moving the objective lens to the right.

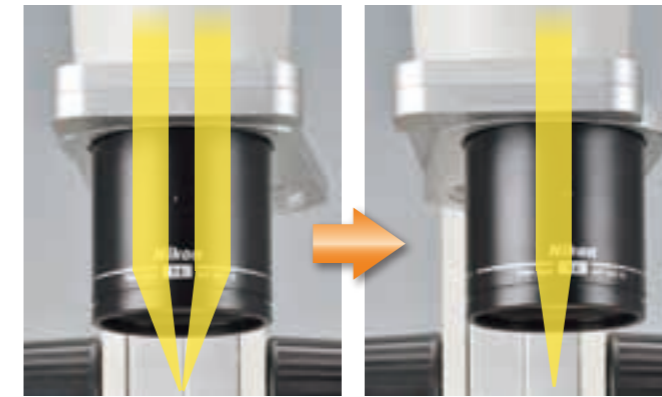

Stereoscopic view

On-axis view

P-RN2 Nosepiece SMZ1270/1270i SMZ800N

Observations with wider zoom ranges are possible by simply switching between two objectives.



P-RNI2 Intelligent Nosepiece SMZ1270i

Enables easy switchover between two objectives. In combination with the Digital Sight series digital camera, it automatically detects the data of objective in use.



Tubes/Eye-level Riser

SMZ1270/1270i SMZ800N

Various ergonomic tubes with different inclination angles enable suitable eye levels to be selected for observation, even when an intermediate tube or illuminator is attached. Trinocular tubes are also equipped with camera ports.

P-B Binocular Tube

20° inclination angle allows observation without having to lean forward and reduces fatigue during long-time operations.



P-TERG100/P-TERG50 Trinocular Tilting Tube

Allows continuous adjustment of the eyepiece inclination from 0° to 30°. Optical path switching ratio of eyepiece:camera port is 100:0/0:100 with P-TERG100 and 100:0/50:50 with P-TERG50.



P-TERG100 Trinocular Tilting Tube

P-TL100 Trinocular Tube

15° of inclination angle allows observation with comfortable posture even when using a thick stand or intermediate tube. Optical path switching ratio of eyepiece:camera port is 100:0/0:100.



P-IER Eye-level Riser

Increases the eyepoint height 25 mm per riser for a total of 50 mm.



Intermediate Tubes

SMZ1270/1270i SMZ800N

Various intermediate accessories are available that can be inserted between the microscope zooming body and tube.

P-IBSS2 Beam Splitter S2

Using a beam splitter and camera adapter, a digital camera can be attached to the binocular eyepiece tube for imaging. Optical path switching ratio of left eyepiece:right eyepiece:camera port is 100:100:0/100:50:50.

P-THSS Teaching Head

Simultaneous observation of the same viewfield is possible between the eyepiece lenses of both teaching head and microscope, making it ideal for educational purposes. The pointer can indicate target points in the viewfield during observation.

P-IDT Drawing Tube

Drawing sample images is possible by simply tracing observed images that are overlaid on top of drawings within the viewfield. The drawings can be removed from view by using the knob to block the light path.

Stages

Stages allow smooth sample movement in order to change viewfield during observation.

C-SSL Dia-sliding Stage

Used for diascopic observation, this sliding stage can be easily moved in the desired direction simply with a light push. Travel range is within $\phi 38\text{mm}$.

SMZ1270/1270i SMZ800N
SMZ745/745T SMZ660
SMZ445/460



Can be used with the SMZ25 and SMZ18

C-TRS Tilting Stage

This stage has a nonslip sheet and can be tilted 30° from its horizontal position.

SMZ1270/1270i SMZ800N
SMZ745/745T SMZ660
SMZ445/460 SMZ-2
SM-5



Can be used with the SMZ25 and SMZ18

Observation Attachments

Various observation accessories are available that utilize diascopic and episcopic illuminations. They can be used for samples that are difficult to observe using standard illumination.

P-EFL Epi-fluorescence Attachment

Up to four epi-fluorescence filter cubes can be mounted. The fly-eye lens provides bright illumination up to the viewfield periphery.

SMZ1270/1270i
SMZ800N



C-POL Polarizing Attachment

Simple polarizing observation is possible by placing the polarizer on the stage while the analyzer is attached to the tip of the objective lens.

SMZ1270/1270i SMZ800N
SMZ745/745T SMZ660



Circular Floating Stage 2

Used for episcopic observation. Loaded with a sample, the stage can be easily moved in the desired direction simply with a light push to its edges. Travel range is within $\phi 40\text{mm}$.

SMZ1270/1270i SMZ800N
SMZ745/745T SMZ660
SMZ445/460 SMZ-2
SM-5



Can be used with the SMZ25 and SMZ18

P-SXY XY Stage

The stage features an XY stroke of $150\text{ mm} \times 65\text{ mm}$. By attaching AZ100 stage adapters, it can be used for various applications. It can be used with both diascopic and episcopic illuminations.

SMZ1270/1270i SMZ800N
SMZ745/745T SMZ660
SMZ445/460

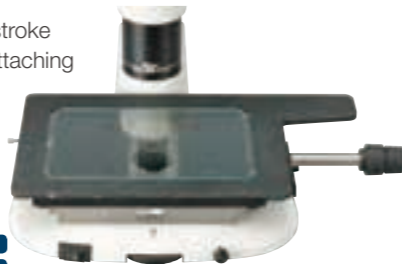

P-DF LED Darkfield Unit

Equipped with the white light LED as the light source. Simply placing the unit on the stage enables darkfield observation.

SMZ1270/1270i
SMZ800N
SMZ745/745T
SMZ660



Illumination Systems

Ring Illuminator

Provides a cone of light from above the sample to the center, minimizing unwanted shadow. Suitable for observation of electronic substrates.



C-FIR Plastic Fiber-optics Ring Illuminator

Illuminator is located away from microscope. It enables bright observation with high-intensity light without damaging sample with its heat.

SMZ1270/1270i SMZ800N SMZ745/745T
SMZ660 SMZ445/460 SMZ-2
SM-5



LMS100 x 60-15W LED Ring Light

Color temperature is adjusted to $6500\text{K} \pm 500\text{K}$ to provide stable illumination. Two types of covers are available. Anti-electrostatic type

SMZ1270/1270i SMZ800N SMZ745/745T
SMZ660 SMZ445/460 SMZ-2
SM-5



SM-LW61Ji3 LED Ring Illuminator

Three types of covers are available (clear, diffuser and opaque white). Anti-electrostatic type

SMZ1270/1270i SMZ800N SMZ745/745T
SMZ660 SMZ445/460 SMZ-2
SM-5

* G-OBA60 Adapter is required.

Arm Illuminator/Episcopic Illuminator

The direction and angle of the illumination can be changed with simple adjustments of the flexible arm.



C-FID2 Double Arm Fiber Illuminator

It enables bright observation with high-intensity light without damaging sample with its heat. The direction and angle of illumination can be changed using the flexible arms.

SMZ1270/1270i SMZ800N
SMZ745/745T SMZ660
SMZ445/460 SMZ-2
SM-5



C-FDF Flexible Double Arm Fiber Illumination Unit

It enables bright observation with high-intensity light without damaging sample with its heat. The direction and angle of illumination can be changed using the fiber holder.

SMZ1270/1270i SMZ800N
SMZ745/745T SMZ660
SMZ445/460



C-LSL LED Episcopic Illuminator

In combination with C-PSN Plain Stand/CN and C-PSCN Compact Stand/CN, illumination angle flexibility is possible from the back of the microscope. By attaching arms, flexible change of direction and angle of illumination is possible.

SMZ1270/1270i SMZ800N SMZ745/745T SMZ660
SMZ445/460

Coaxial Illuminator

Suitable for brightfield observation for high-reflectance flat surface samples such as polished metals and wafers.

P-CI Coaxial Episcopic Illuminator

Coaxial illuminator for parallel optics-type stereo microscopes. Provides high-intensity illumination for the entire view field.

* $1/4 \lambda$ plate is required

SMZ1270/1270i SMZ800N



G-ICIL LED Coaxial Episcopic Illuminator

Coaxial illuminator for Greenough-type stereo microscopes. Equipped with both coaxial episcopic and oblique illumination, which illuminates from behind the microscope.

SMZ745/745T SMZ660



System Diagrams (SMZ25/SMZ18)

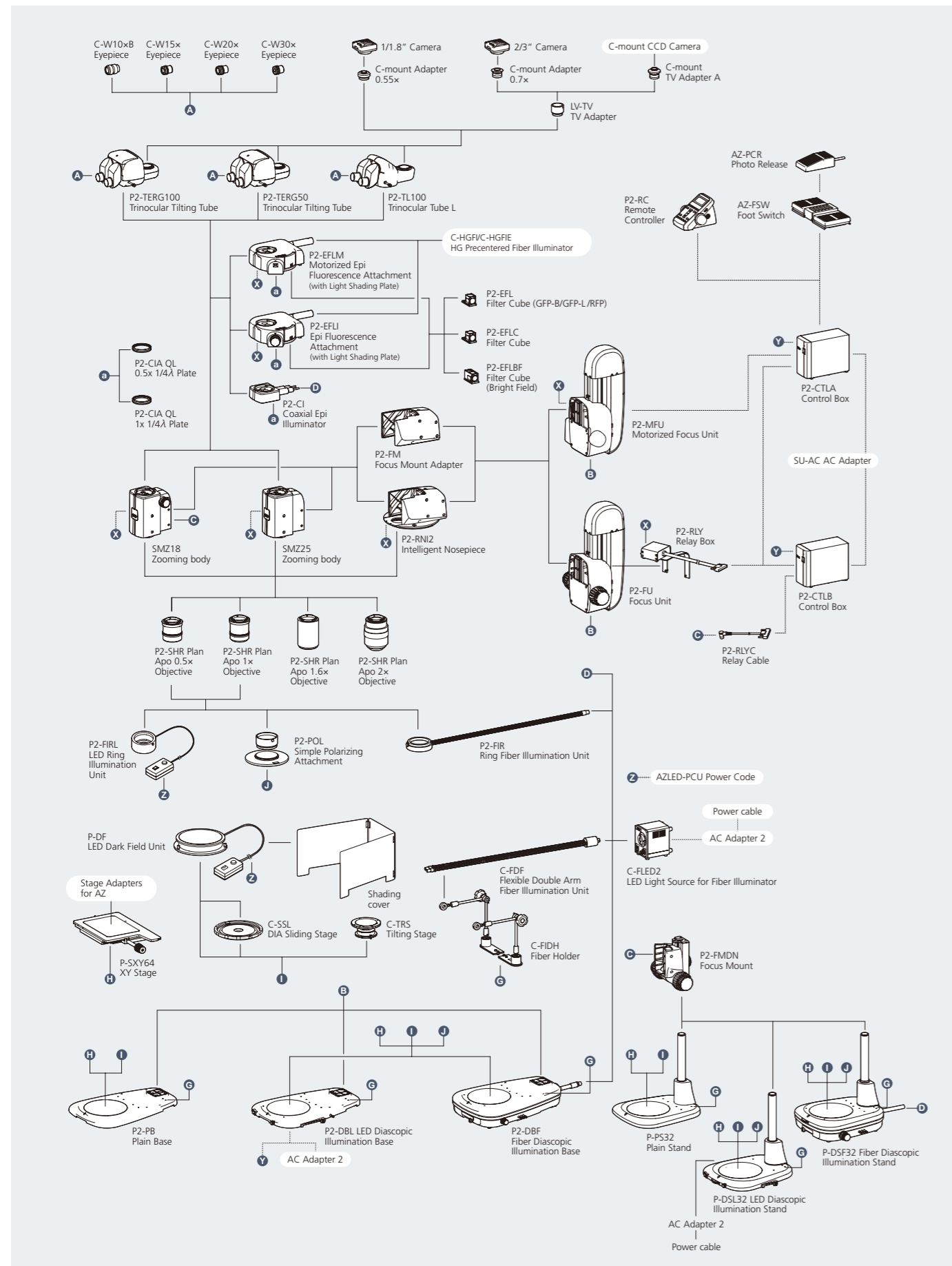

Specifications/Dimensions (SMZ25/SMZ18)

	SMZ25	SMZ18
Zooming body		
Optical system	Parallel-optics type (zooming type), apochromatic optical system	
Zoom	Motorized	Manual
Zoom ratio	25:1	18:1
Zoom range	0.63-15.75x	0.75-13.5x (with 0.75/1/2/3/4/5/6/8/10/12/13.5x click stops)
Aperture diaphragm	Zooming body built-in	
Objectives NA, WD (mm)		
P2-SHR Plan Apo 2x	0.312, 20 (with a correction ring for water 0 to 3 mm in depth)	0.3, 20 (with a correction ring for water 0 to 3 mm in depth)
P2-SHR Plan Apo 1.6x	0.25, 30	0.24, 30
P2-SHR Plan Apo 1x	0.156, 60	0.15, 60
P2-SHR Plan Apo 0.5x	0.078, 71	0.075, 71
Total Magnification (using C-W10xB eyepieces)	3.15-315x (depending on objective used)	3.75-270x (depending on objective used)
Eyepieces (F.O.V. mm)	• C-W10xB (22) • C-W 15x (16) • C-W 20x (12.5) • C-W 30x (7)	
Tubes (eyepiece/port)	• P2-TERG 100 Trinocular Tilting Tube (100/0 : 0/100) • P2-TERG 50 Trinocular Tilting Tube (100/0 : 50/50) Inclination angle : 0-30 degree • P2-TL100 Trinocular Tube L (100/0 : 0/100) Inclination angle : 15 degree	
Focusing Unit (stroke from objective's parfocal point)	• P2-MFU Motorized Focus Unit (up 96 mm/down 4 mm) • P2-FU Focus Unit (up 97 mm/down 5 mm)	
Focus mount adapter/nosepiece	• P2-FM Focus Mount Adapter • P2-RNI2 Intelligent Nosepiece (2 objectives can be attached)	• P2-FM Focus Mount Adapter • P2-RNI2 Intelligent Nosepiece (2 objectives can be attached) • P2-FMDN Focus Mount (for P-PS32/P-DSL32/P-DSF32 stands)
Bases/stand	• P2-PB Plain Base • P2-DBL LED Diascopic Illumination Base (OCC illuminator built-in) • P2-DBF Fiber Diascopic Illumination Base • P-PS32 Plain Stand (only for SMZ18) • P-DSL32 LED Diascopic Illumination Stand (OCC illuminator built in) (only for SMZ18) • P-DSF32 Fiber Diascopic Illumination Stand (only for SMZ18)	
Stages	• P-SXY64 Stage • C-SSL DIA Sliding Stage • C-TRS Tilting Stage	
Observation methods	Bright Field, Epi Fluorescence, Simple Polarizing (with P2-POL Simple Polarizing Attachment), Dark Field (with P-DF LED Dark Field Unit), Oblique Lighting	
Epi-fluorescence attachments	4 filter cubes mountable, fly-eye lens built-in • P2-EFLM Motorized Epi Fluorescence Attachment • P2-EFLI Epi Fluorescence Attachment	
Epi-fluorescence light sources	• HG Precentered Fiber Illuminator Intensilight C-HGFIE HG/C-HGFI HG (130W)	
Episcopic illuminators	Use with fiber light source • P2-FIR Ring Fiber Illumination Unit • C-FDF Flexible Double Arm Fiber Illumination Unit	
Episcopic light source	• C-FLED2 LED Light Source for fiber illuminator	
Weight (approx.)	32 kg (Motorized Epi Fluorescence Attachment configuration with Trinocular Tilting Tube, Motorized Focus Unit, Intelligent Nosepiece, LED DIA Base and Objectives 1x and 0.5x)	30 kg (Epi Fluorescence Attachment configuration with Trinocular Tilting Tube, Focus Unit, Intelligent Nosepiece, LED DIA Base and Objectives 1x and 0.5x)
Power consumption (approx.)	30W (Motorized Epi Fluorescence Attachment configuration with Trinocular Tilting Tube, Motorized Focus Unit, Intelligent Nosepiece and LED DIA Base)	10W (Epi Fluorescence Attachment configuration with Trinocular Tilting Tube, Focus Unit, Intelligent Nosepiece and LED DIA Base)

Dimensions

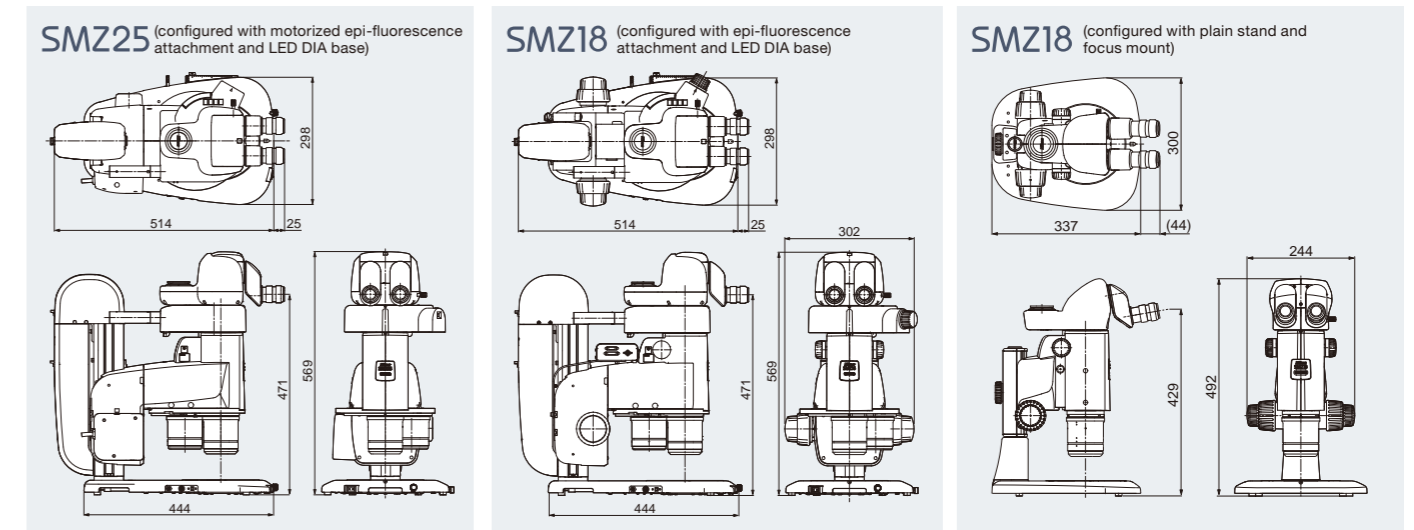

System Diagrams (SMZ1270/1270i, SMZ800N, SMZ745/745T)

SMZ1270/1270i/800N

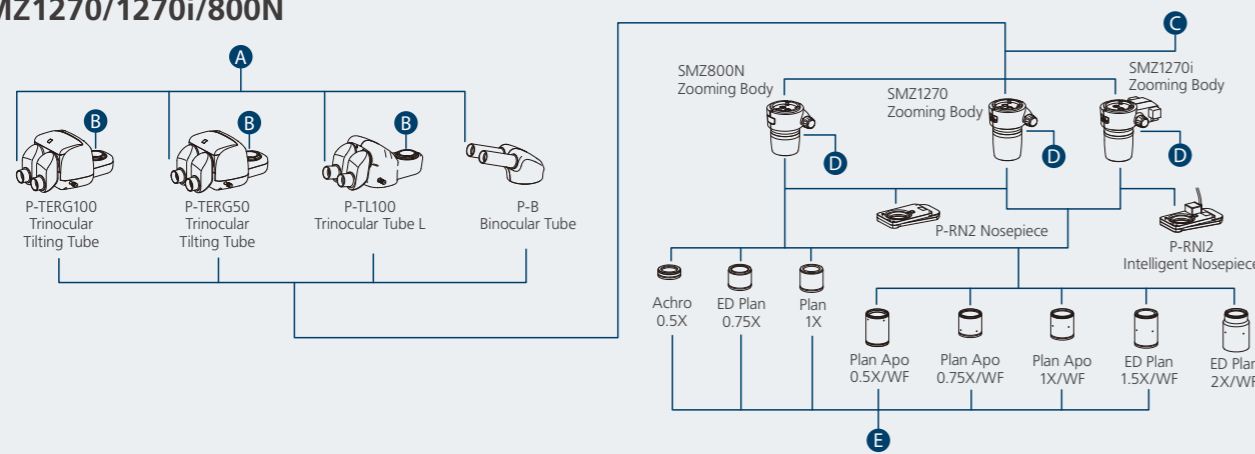

SMZ745/745T

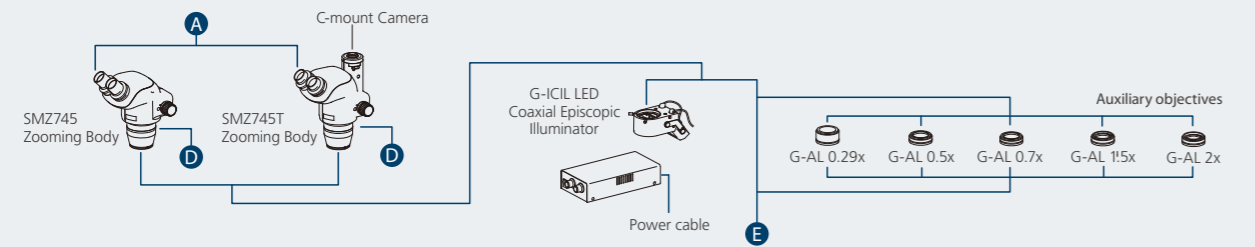

Eyepieces/Camera Adapters

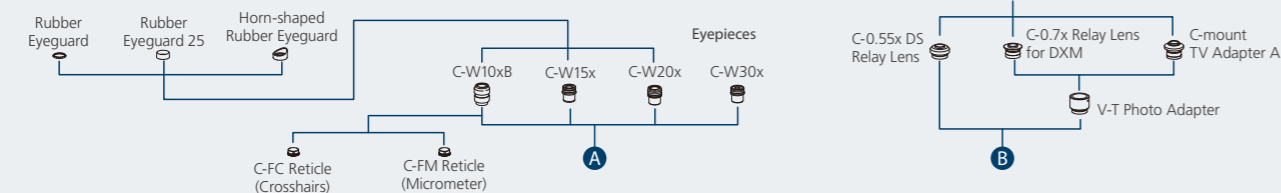

Intermediate Tubes

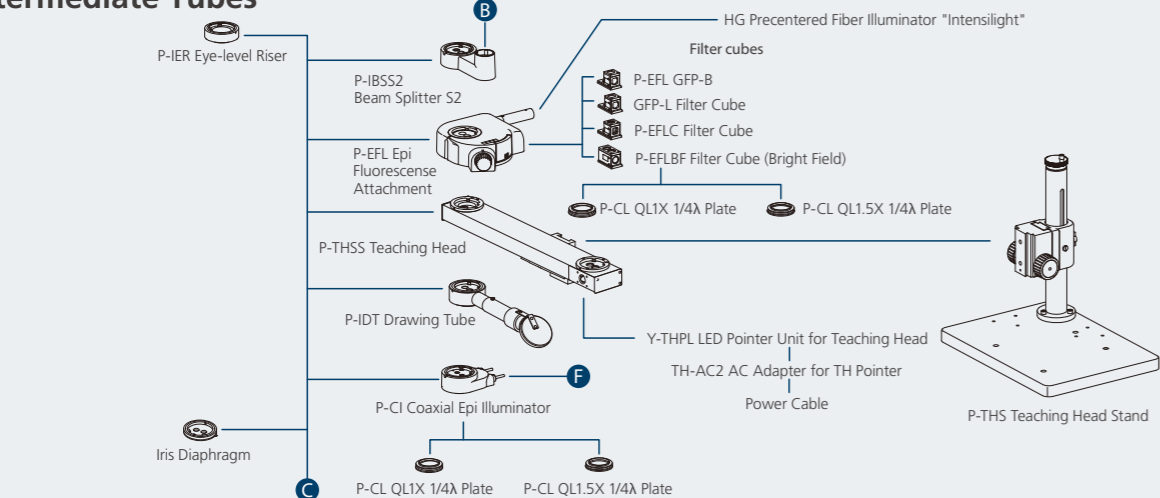

Illuminators

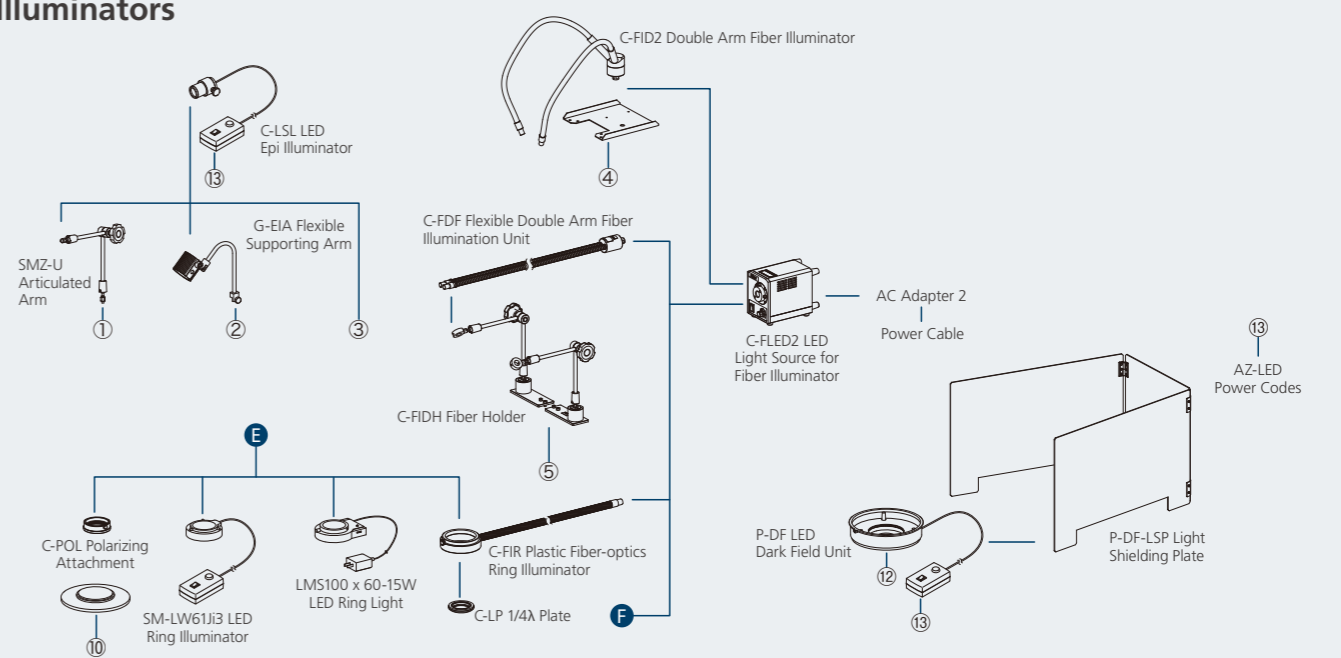

Stands/Stages

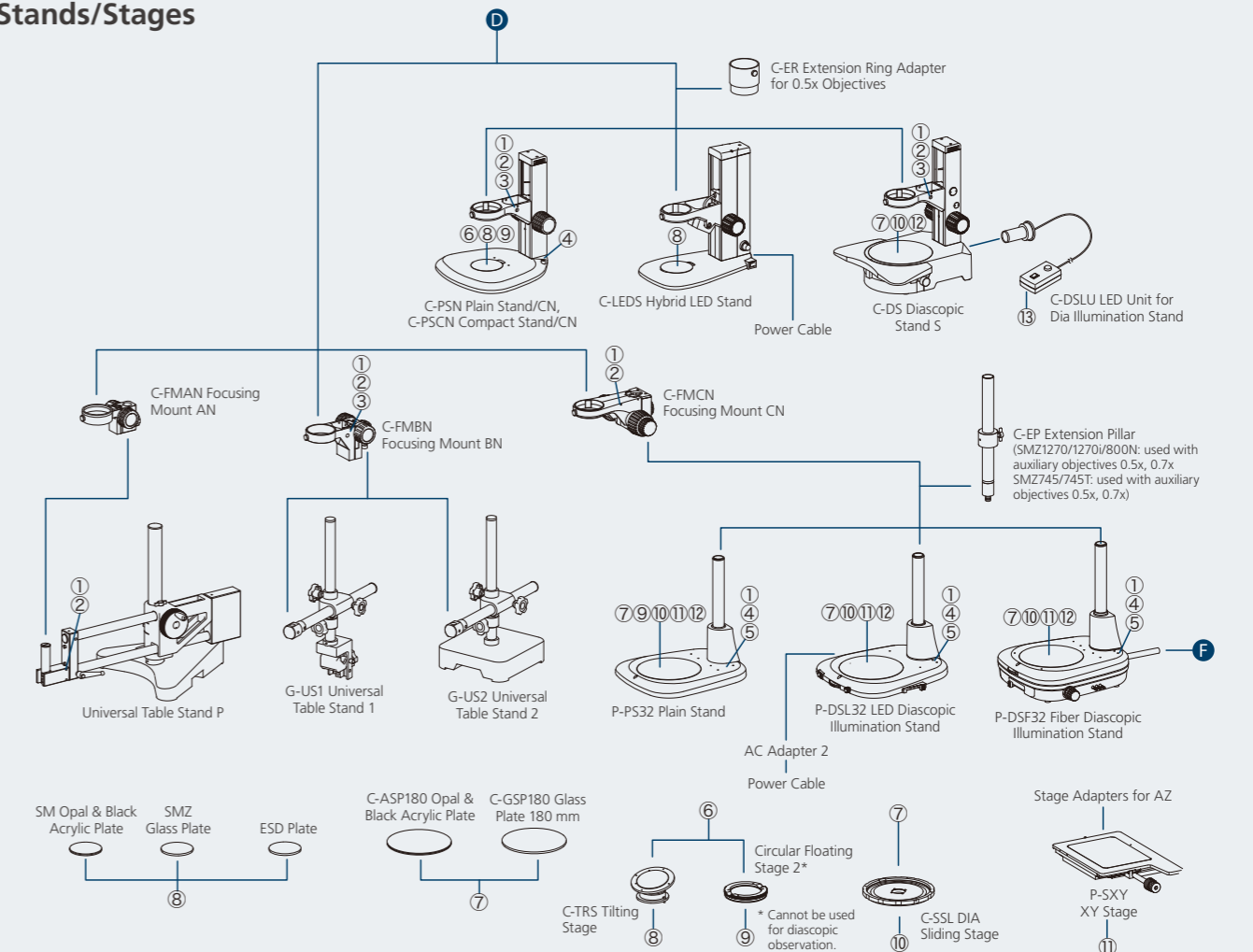

Specifications

Parallel-optics type						
Model	SMZ25		SMZ18	SMZ1270	SMZ1270i	SMZ800N
Optical system	Parallel-optics type (zooming type)			Parallel-optics type (zooming type)		
Zoom ratio	25:1		18:1	12.7:1		8:1
Zoom range	0.63-15.75x		0.75-13.5x	0.63 – 8x		1 – 8x
Total magnification* (When coaxial episcopic illuminator is attached)	3.15-945x (12.5-472x)		3.75-810x (19-405x)	3.15 – 480x (depending on eyepiece and objectives) (with coaxial episcopic illuminator: 15 – 540x)		5 – 480x (depending on eyepiece and objectives) (coaxial episcopic illuminator: 22.5 – 540x)
Tubes	P2-TERG 100 Trinocular Tilting Tube, P2-TERG 50 Trinocular Tilting Tube, P2-TL100 Trinocular Tube L			P-B Binocular Tube, P-TL100 Trinocular Tube, P-TERG 100 Trinocular Tilting Tube, P-TERG 50 Trinocular Tilting Tube		
Eyepiece inclination	P2-TERG 100/50: 0°-30°, P2-TL100: 15°			P-B: 20° P-TL100: 15° P-TERG100/50: 0°-30°		
Interpupillary distance adjustment	P2-TERG 100/50: 50 mm or wider P2-TL100: 50-75mm			P-B: 48-75mm P-TL100: 50-75mm P-TERG100/50: 50 mm or wider		
Eyepieces	C-W10xB (F.N. 22), C-W15x (F.N. 16), C-W20x (F.N. 12.5), C-W30x (F.N. 7) (with diopter adjustment)			C-W10xB (F.N. 22), C-W15x (F.N. 16), C-W20x (F.N. 12.5), C-W30x (F.N. 7) (with diopter adjustment)		
Objectives	P2-SHR Plan Apo 0.5x, P2-SHR Plan Apo 1x, P2-SHR Plan Apo 1.6x, P2-SHR Plan Apo 2x			Plan Apo 0.5x/WF, Plan Apo 0.75x/WF, Plan Apo 1x/WF, ED Plan 1.5x/WF, ED Plan 2x/WF		Plan Apo 0.5x/WF, Plan Apo 0.75x/WF, Plan Apo 1x/WF, ED Plan 1.5x/WF, ED Plan 2x/WF, Plan 1x, ED Plan 0.75x, Achro 0.5x
Working distance (with standard configuration or 1x objective)	60 mm			70 mm		78 mm
Weight (approx.)	32 kg (motorized Epi Fluorescence Attachment configuration)		10 kg (with Plain Stand and Ring LED set)	9.8 kg (with Binocular Tube + LED Diascopic Illumination Stand)	11.9 kg (with Trinocular Tilting Tube + LED Diascopic Illumination Stand)	6.8 kg (with Binocular Tube + Plain Stand)

* Depending on eyepiece and objective used

Greenough type						
Model	SMZ745/745T	SMZ660	SMZ445	SMZ460	SMZ-2	SM-5
Optical system	Greenough type (zooming type) Trinocular Tube (SMZ745T)		Greenough type (zooming type)		Greenough type (zooming type) Fixed type	
Zoom ratio	7.5 : 1		6.3 : 1		4.4 : 1	
Zoom range	0.67-5x		0.8-5x		0.8-4x	
Total magnification*	3.35-300x		4-300x		4-120x	
Tubes	Fixed (binocular tube: SMZ745, trinocular tube: SMZ745T)		Fixed		Fixed	
Eyepiece inclination	45°		60°		45°	
Interpupillary distance adjustment	52-75mm		54-75mm		56-75mm	
Eyepieces	C-W10xB (F.N. 22), C-W15x (F.N. 16), C-W20x (F.N. 12.5), C-W30x (F.N. 7) (with diopter adjustment)		SM 10xB (F.N. 21), SM 15xB (F.N. 14), SM 20xB (F.N. 12)		SM 10xB (F.N. 21), SM 15xB (F.N. 14), SM 20xB (F.N. 12)	
Objectives	-		-		0.8-4x	
Auxiliary objectives	G-AL 0.5x (W.D. 211mm), 0.7x (W.D. 150mm), 1.5x (W.D. 61mm), 2x (W.D. 43.5mm)		G-AL ERG 0.77-1.06x (W.D. 102-48mm)		SM-AL 0.5x, 0.7x	
Working distance (with standard configuration or 1x objective)	115mm		100mm		100mm	
Weight (approx.)	1.6kg (SMZ745 body) 1.8kg (SMZ745T body)		1.6kg (body)		1.0kg (body)	
					1.1kg (body)	
					1.6kg (body), 1.9kg (Stand)	
					0.9kg (body), 1.9kg (Stand)	

* Depending on eyepiece and objective used

Related Products

Digital Cameras for Microscopes

PC-use Control Unit **DS-U3** + **NIS-Elements** Imaging Software

Enables a wide range of advanced digital imaging capabilities using a PC

EDF (Extended Depth of Focus)

option: **Ar Br D**

Captures multiple high-resolution images at different focal depths to create a single extended depth of focus image or quasi-3D image.

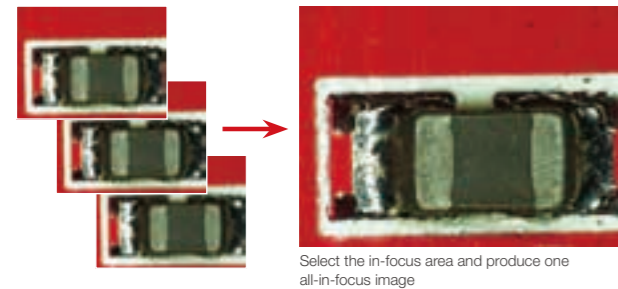

Select the in-focus area and produce one all-in-focus image

Time lapse

NIS-Elements makes it easy to set up a time-lapse imaging experiment.

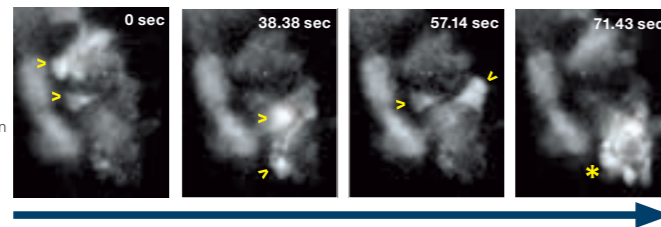

Calcium-imaging: Time-lapse imaging of GCaMP expressing neurons inside a live zebrafish shows individual neurons firing at different times (arrowheads). The last time-frame shows a whole cluster of neurons firing (asterisk).

(Using SHR Plan Apo 2x at zoom magnification of 9x with SMZ25 and camera head DS-Qi1) Image courtesy of Joe Fetcho, Ph.D., Cornell University

Standalone Control Unit **DS-L3**



Offers an easy-to-use high-definition, large-touch-panel monitor that can be used to quickly capture images without the use of a PC or monitor.

Scene mode

Optimal imaging parameters for each sample type and observation method can easily be set using the icons.

Scene mode (bioscience)	Scene mode (industrial)
Darkfield/fluorescence	Wafer/IC-chip
Differential interference/phase contrast	Metal/ceramic
Brightfield	Board
HE staining	FPD
Enzyme labeled antibody method	

Various tools

Simple measurements of acquired image are possible, allowing lines and comments to be added to image data. In addition, data storage and output functions for a wide range of applications are available.

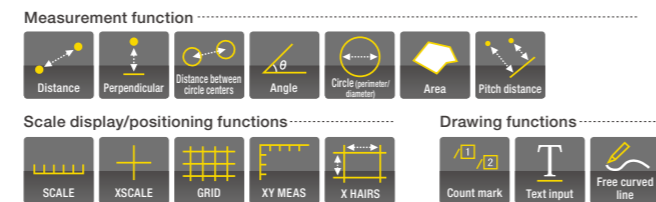

Camera Heads

Ultra high-definition cooled color camera head

DS-Ri1

12.7 mega-pixels Color Cooled High-resolution



High-definition Color Camera Head

DS-Fi2

5.0 mega-pixels Color High-resolution



High-sensitivity cooled monochrome camera head

DS-Qi1

1.5 mega-pixels Cooled



* For more information, see the Digital Sight Series and NIS-Elements brochures.

Digital Microscope

ShuttlePix

ShuttlePix provides 20x optical zoom. Its magnification information is also linked to ShuttlePix's scale and simple measurement functions.



Easy imaging

- Step. 1 Turn on the power.
- Step. 2 Adjust magnifications and focusing while observing the monitor.
- Step. 3 Press the image capture button.



One touch EDF imaging

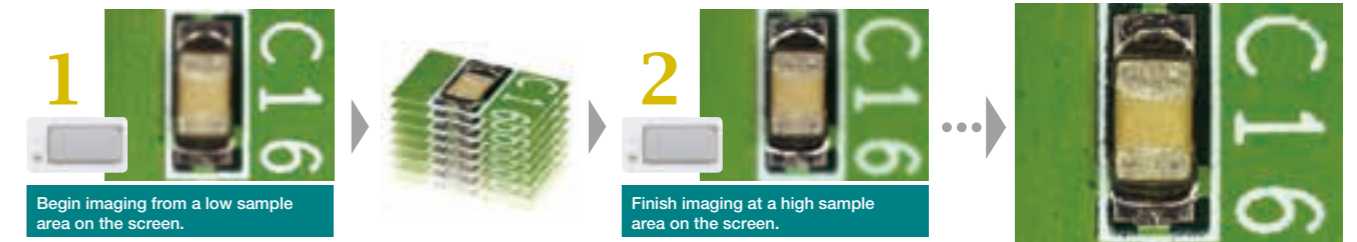

Others

Handy set

- A cordless body (built-in illuminator, compatible with SD card, battery-powered)
- Easy operation



Simple stand set

- Simple reflection stand that requires no battery
- Diascopic LED stand enables diascopic imaging
- Automatically uploads images to a PC



Multi-purpose Zoom Microscope

MULTIZOOM AZ100 AZ100M

- Wide magnification range
- Various observation methods in the macro region are possible depending on samples and purpose.

Wide magnification range

0.5x, 1x, 2x, 4x and 5x objectives are available. Used in combination with the AZ-W10x eyepiece and a coaxial episcopic illuminator, the AZ100 series covers the full range of 5x to 500x magnifications.

Various observation methods

The AZ series mono-zoom mechanism enables true on-axis image capture in the macro region. The AZ series supports a wide array of observation methods, including epi-fluorescence, reflected/transmitted light brightfield, simple POL and differential interference contrast

