

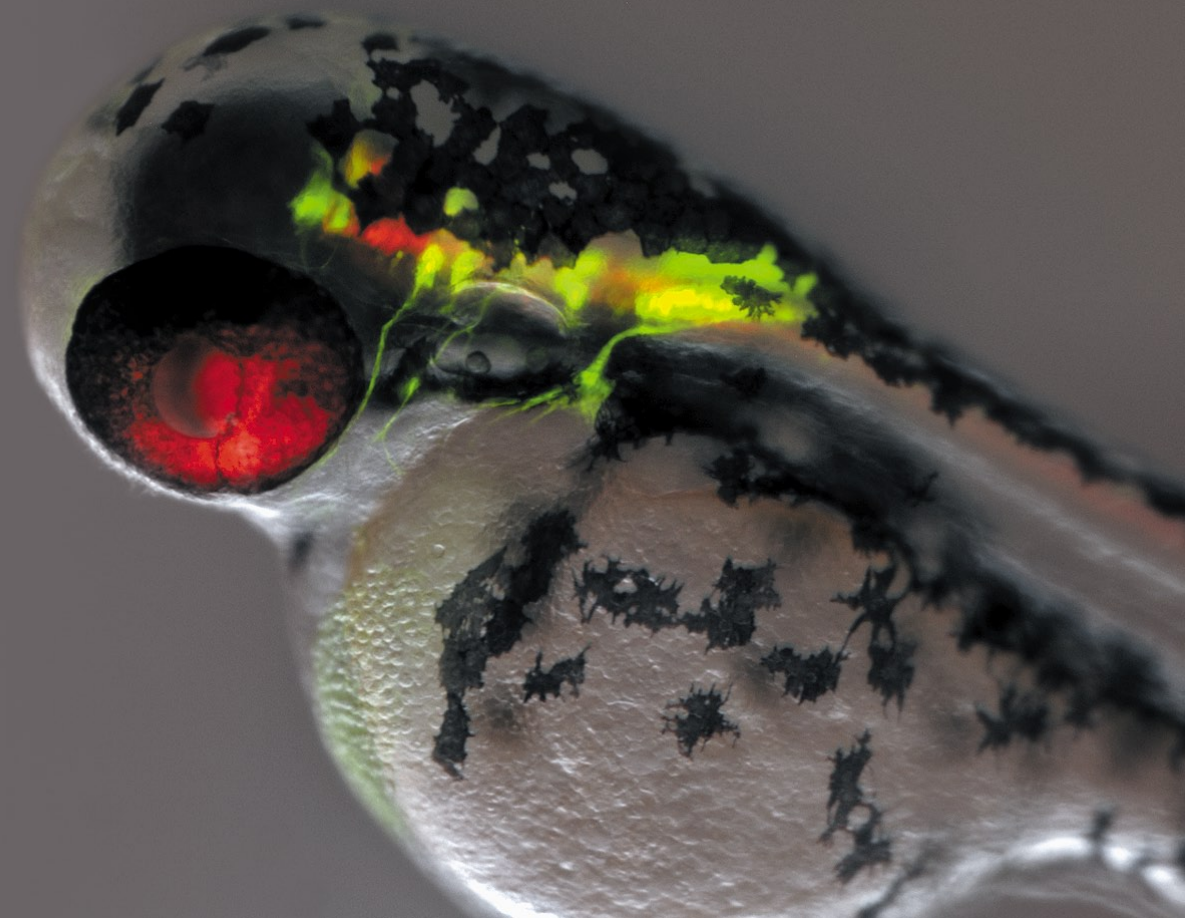

Research Stereo Microscope SMZ25/18

Research Stereo Microscope

SMZ25  
SMZ18



Live zebrafish expressing GFP- and RFP-neurons, imaged with Nikon's latest research stereo microscope, the SMZ25 (fluorescence and OCC).  
Image courtesy of Joe Fetcho, Ph.D., Cornell University.

# Discover a New Evolution Giant Step Forward in Stereo Microscopy

Traditional boundaries between scientific fields such as molecular biology and developmental biology are rapidly disappearing as researchers seek to connect findings at the molecular level to those derived from cellular, tissue, and organismal studies. Fields including molecular biology, cell biology, neurobiology, embryology, developmental biology and systems biology have increasing needs for imaging systems that span spatial scales from single cells to whole organisms.

With these demands in mind, Nikon has developed an all new stereo microscope that features a large zoom ratio of 25:1, high resolution and exceptional fluorescence transmission capability.

This latest edition to the SMZ series represents a landmark in stereo microscope evolution – one that guarantees your research will be elevated to the next level.

## World's largest zoom range and highest resolution in the SMZ series

- First stereo microscope to offer a 25:1 zoom range (SMZ25)
- Both eye paths boast numerical apertures (NA) of up to 0.156, using the SHR (Super High Resolution) Plan Apo 1x objective and SMZ25 zooming body

## Bright and high contrast fluorescent images

- Fly eye lens ensures uniform brightness over the entire field of view even at the lowest magnifications
- Breakthroughs in optical design result in significantly improved signal to noise ratio and crystal clear fluorescent images

## Automation and digital imaging

- Motorized focus and zoom operation (SMZ25)
- Imaging Software NIS-Elements enables the use of multiple imaging, processing and analysis modalities including z-stack capture, time-lapse imaging, and the generation of EDF images

## Easy to use

- User-friendly remote control (SMZ25)
- Easy-to-operate slim LED DIA base with OCC illumination
- Wide range of illuminators and accessories accommodate a variety of observation methods

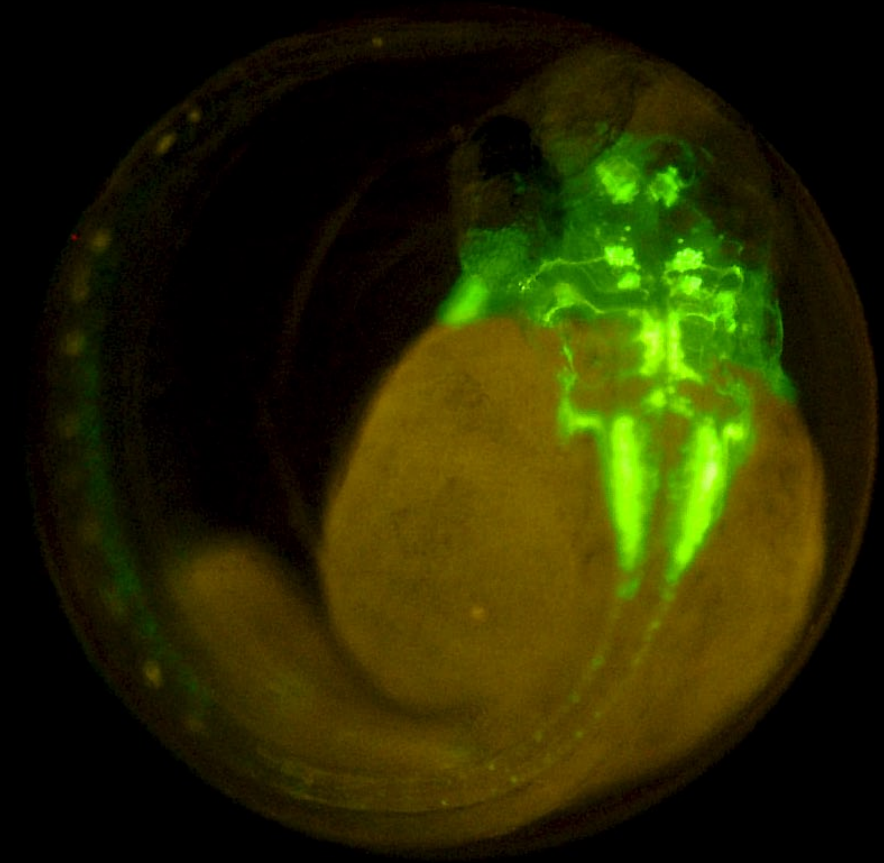

2 days old Transgenic Zebrafish embryo, Tg (Isl1-GFP)  
(using SHR Plan Apo 1x at zoom magnification of 6x with SMZ25)  
Image courtesy of Hisaya Kakinuma, Ph.D.  
Laboratory for Developmental Gene Regulation,  
Developmental Brain Science Group,  
RIKEN Brain Science Institute



## SMZ25

Motorized zoom model  
with the highest zoom  
ratio and resolution  
in the SMZ series



## SMZ18

Manual zoom model  
providing advanced optical  
performance and incredibly  
bright fluorescence at an  
economical cost

	Motorized zoom	Manual zoom
Zooming observation	BF/DF/FL/Simple polarizing	BF/DF/FL/Simple polarizing
Zoom ratio	25:1	18:1
Magnification range	0.63x ~ 15.75x	0.75x ~ 13.5x
Maximum magnification	315x*1	270x*1
Maximum FOV	ø70mm*2	ø59mm*2
Maximum NA of objective	0.312*3	0.3*3

\*1: Using SHR Plan Apo 2x/C-W 10x \*2: Using SHR Plan Apo 0.5x/C-W 10x \*3: Using SHR Plan Apo 2x



# World's largest zoom range and incredible resolution

## Dynamic zoom ratio of 25:1 SMZ25

An innovative optical system known as Perfect Zoom System provides the world's first zoom ratio of 25:1 (zoom range: 0.63x - 15.75x). Even with a 1x objective lens, the SMZ25 captures the entire 35mm dish and simultaneously delivers microscopic details.

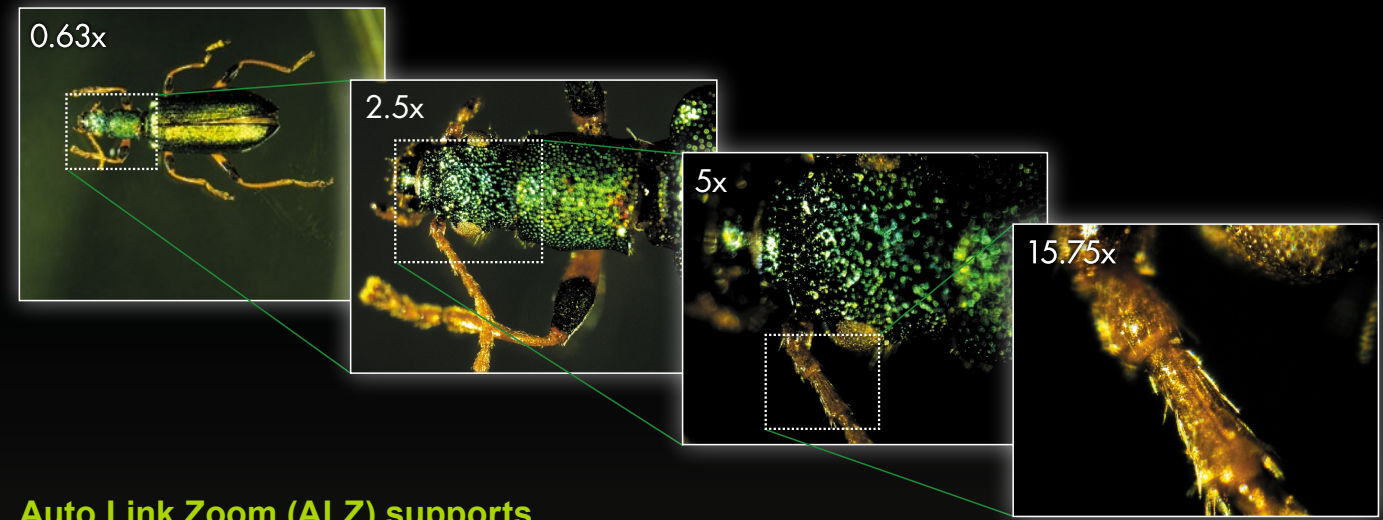

*Arthromacra sp.*  
(Using SHR Plan Apo 1x with SMZ25)  
Image courtesy of Japan Insect Association

## Auto Link Zoom (ALZ) supports seamless viewing at different scales SMZ25

ALZ automatically adjusts the zoom factor to maintain the same field of view when switching objective lenses. This function enables seamless switching between whole organism imaging at low magnifications and detailed imaging at high magnifications.

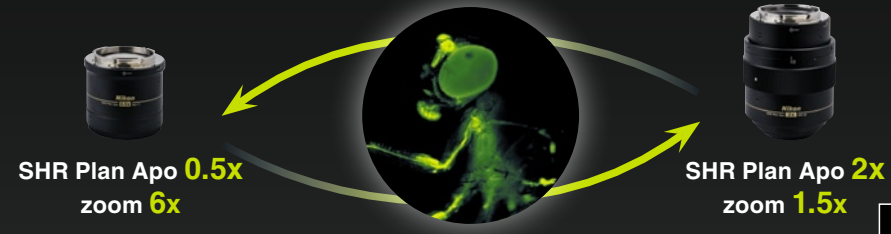

Maintains FOV at total magnification of 3x

Adult Drosophila, pebbled-Gal4 drive membrane-bound GFP expression in partial cells (with SMZ25)  
Image courtesy of Hokuto Kazama, Ph.D. Laboratory for Circuit Mechanisms of Sensory Perception RIKEN

## Offers the highest zoom ratio thanks to Nikon's Perfect Zoom System SMZ25

A breakthrough in stereoscope design, Perfect Zoom System dynamically change the distance between the two optical axes as the zoom factor is changed. This change in optical axis distance enables maximization of light entry into the optical system at every magnification. The result is an uncompromised, large zoom range, high resolution in both eye paths, and minimal aberrations over the entire zoom-range. Furthermore, this breakthrough in optical design enables all of these desirable features to be housed in a compact zoom body, resulting in an ergonomic instrument design.

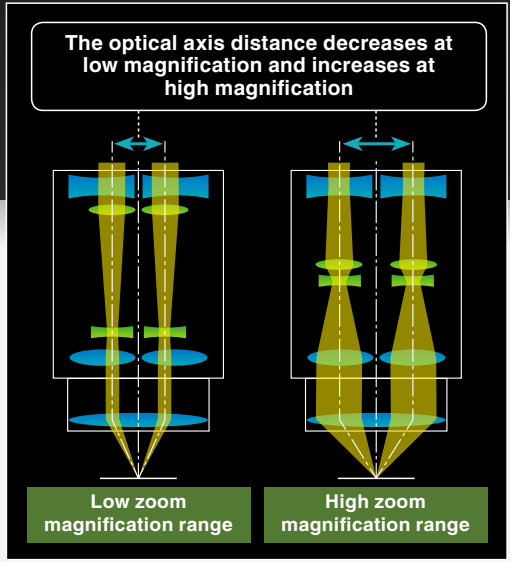

Higher NA in both eye paths coupled with a superior zoom ratio provides seamless viewing on the macro and micro levels.

## Superior resolution never before seen on a stereomicroscope

Nikon's SMZ25 series offers superior NA of 0.156 on the SHR Plan Apo 1x and 0.312 on the SHR Plan Apo 2x. Traditionally, researchers have had to switch to a higher magnification microscope to view microscopic details after using a stereo microscope to view or manipulate macroscopic structures. Nikon's SMZ25/18 eliminates this need by providing both macroscopic and microscopic imaging capabilities. For example, the SHR Plan Apo 2x objective allows for visualization of structures as small as a few microns in size, which was once considered to be impossible on a stereo microscope. Apochromatic correction is maintained in both the objective lens and the optical zoom system, virtually eliminating color aberrations.

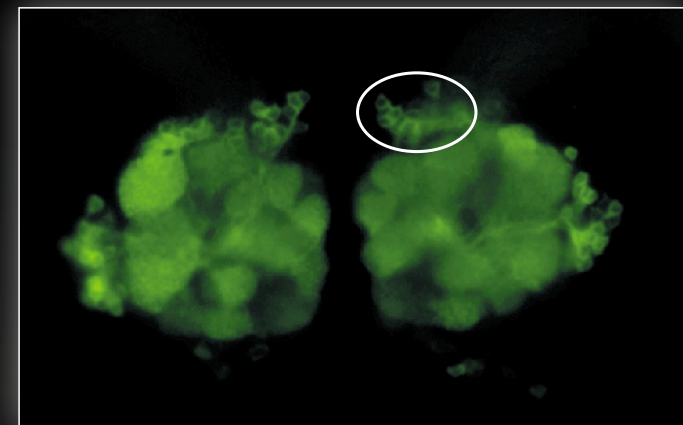

Individual olfactory nerve cells in a drosophila expressing a GFP-membrane marker are clearly resolved as black bodies encircled by fluorescent membranes (see circled area). This image demonstrates the SMZ25's incredible high resolution as the olfactory cells are typically only  $\phi 5\mu\text{m}$  in diameter

Drosophila brain, GFP-G  
(using SHR Plan Apo 2x at zoom magnification of 15.75x with SMZ25)  
Image courtesy of Hokuto Kazama, Ph.D.  
Laboratory for Circuit Mechanisms of Sensory Perception RIKEN

## A single motor neuron expressing clusters of GFP-glycine receptors (resolved as individual puncta along the cell body and processes) imaged in a live zebrafish

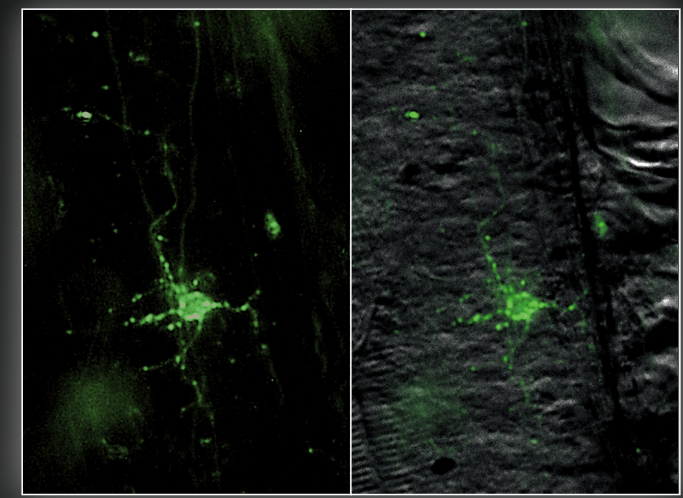

Zebrafish (GFP and OCC)  
(using SHR Plan Apo 2x at zoom magnification of 15.75x with SMZ25)  
Image courtesy of Joe Fetcho, Ph.D., Cornell University

## Newly developed high-performance objective lens SMZ25 SMZ18

Nikon's newly developed objective lens series, the SHR Plan Apo series, offers a high resolution of 1100LP/mm (Observed value, using SHR Plan Apo 2x at maximum zoom). The new SHR Plan Apo series of lenses deliver brilliant images with true-to-life colors.

### Comparison of resolution by resolution chart

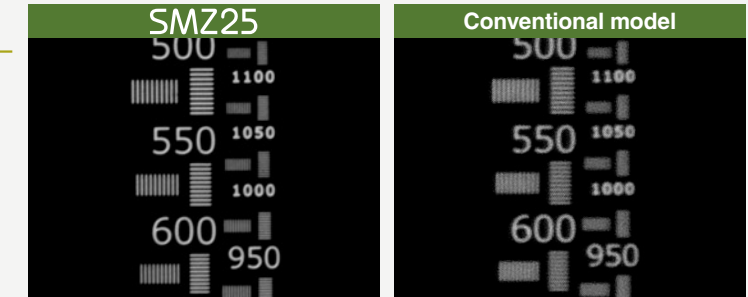



# Bright and high contrast fluorescent images

## Enhanced brightness and uniform illumination in low magnification range

Even at low magnification, the SMZ25 series captures the entire 35mm dish with equal brightness over the whole field of view\*, making these new stereo microscopes ideal for live screening of developmental models such as *C. elegans*, drosophila, zebrafish, and mice to identify and select mutants. The SMZ25 series also allows brilliant images to be captured even with low excitation light levels, minimizing photo-bleaching and photo-toxicity which is harmful to live cells and organisms. \*Using SMZ25/SHR Plan Apo 1x

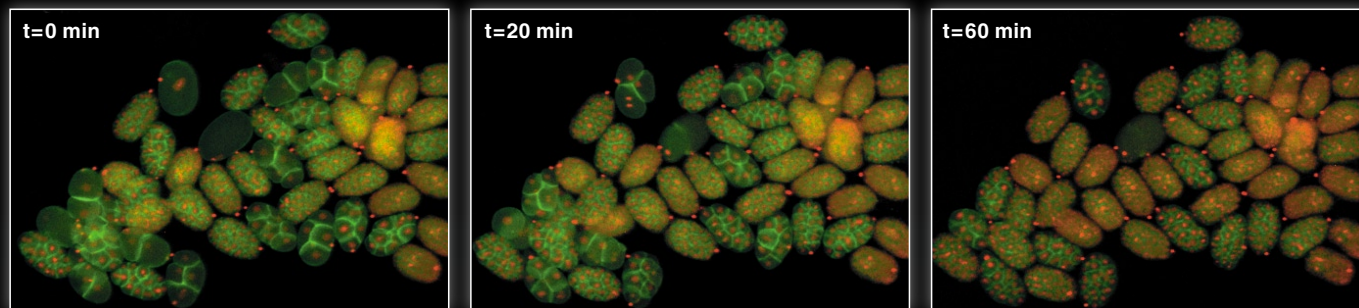

Time-lapse imaging of developing *C. elegans* embryos expressing RFP-histones and GFP-membrane markers allows researchers to screen for cytokinesis mutants prior to selection for downstream applications

*C. elegans* embryos (GFP and RFP; each ovoid is  $\phi 30\mu\text{m}$  in diameter) (using SHR Plan Apo 2x at zoom magnification of 8x with SMZ25)  
Image courtesy of Julie C. Canman, Ph.D., Columbia University.

12.5 days old mouse embryo, Red: Nucleus (Using SHR Plan Apo 0.5x at zoom magnification 1.30x with SMZ18)  
Image courtesy of Kazuo Yamagata, Ph.D. Center for Genetic Analysis of Biological Responses, Research Institute for Microbial Diseases, Osaka University



Newly developed epi-fluorescence attachment captures clear fluorescence images.

## Improved S/N ratio and crystal clear fluorescent images thanks to an improved optical system

Nikon's newly developed optical system offers a drastic improvement in S/N ratio even at high magnifications. This improved S/N ratio makes it possible to capture cell division, which is difficult using conventional stereo microscopes, and samples with low excitation light.

The spindle appearing in cell division can be observed

Fertilized mouse egg, Green: Spindle (EGFP-  $\alpha$  tubulin), Red: Nucleus (Histone H2B-mRFP1) (using SHR Plan Apo 1x at zoom magnification of 13.5x with SMZ25)  
Image courtesy of Kazuo Yamagata, Ph.D. Center for Genetic Analysis of Biological Responses, Research Institute for Microbial Diseases, Osaka University

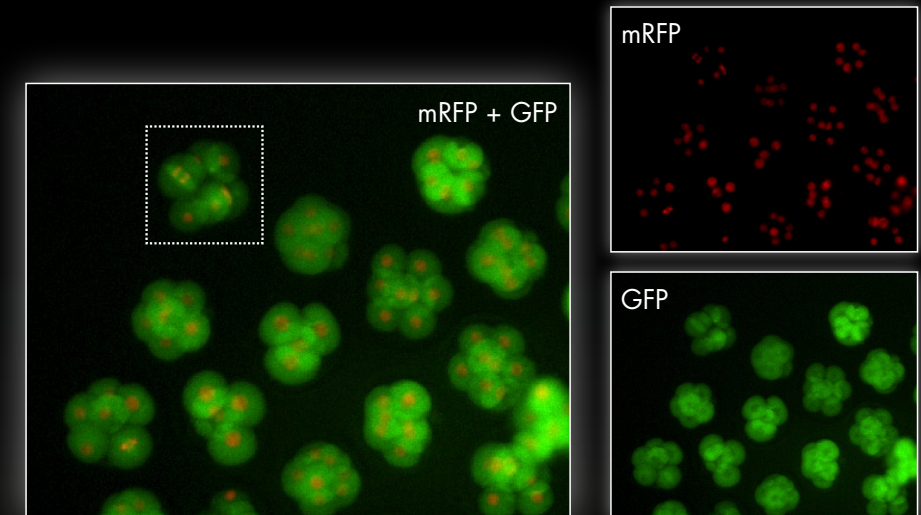

Single fluorescent neurons can be visualized in live *C. elegans*

Fluorescence and OCC images of a live *C. elegans* expressing GFP- and RFP-neurons (using SHR Plan Apo 2x at zoom magnification of 3x with SMZ25)  
Image courtesy of Julie C. Canman, Ph.D., Columbia University

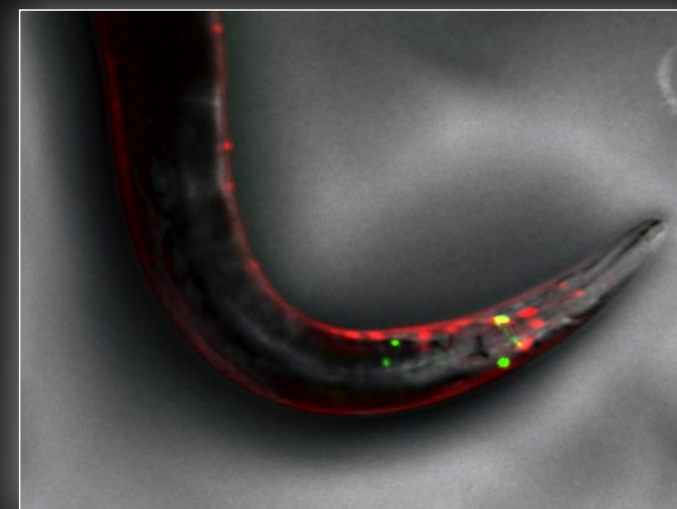

## Fly eye lens ensures uniform brightness over the entire field of view SMZ25 SMZ18

The SMZ25 series is the first stereo microscope in the world to use a fly eye lens on an epi-fluorescence attachment. This innovative design ensures bright and uniform illumination even at low magnifications, resulting in uncompromised uniformity in brightness across a large field of view.

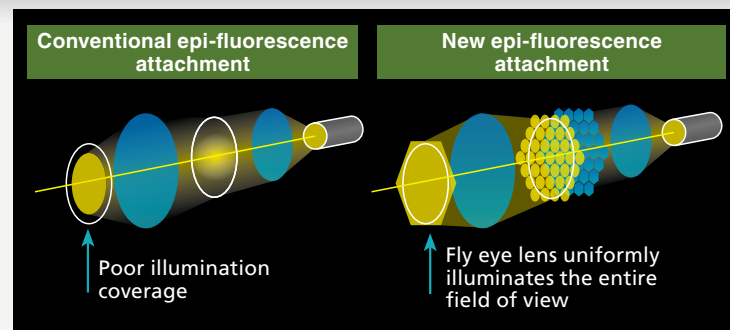

## Zoom body with significant improvements in optical performance SMZ25 SMZ18

Nikon has succeeded in improving the signal and reducing noise in fluorescent images by using a short wavelength, high transmission Fluor lens. Combined with an innovative epi-fluorescence attachment, the SMZ18/25 is better able to detect excitation light than conventional fluorescent stereo microscopes.



# Automation and digital imaging

A wide range of digital imaging capabilities with the Digital Sight series and NIS-Elements imaging software.

## User-friendly remote controller SMZ25

The all new remote controller provides easy access to zoom and focus controls and is designed for both right and left hand use. The remote controller contains an LCD monitor with an adjustable backlight which provides information regarding the zoom factor, objective lens, filter cube, and LED DIA brightness at a glance. The backlight on the LCD monitor can also be turned off to eliminate interference with low-light imaging applications. In addition to the remote controller, the microscope can also be operated through a PC.

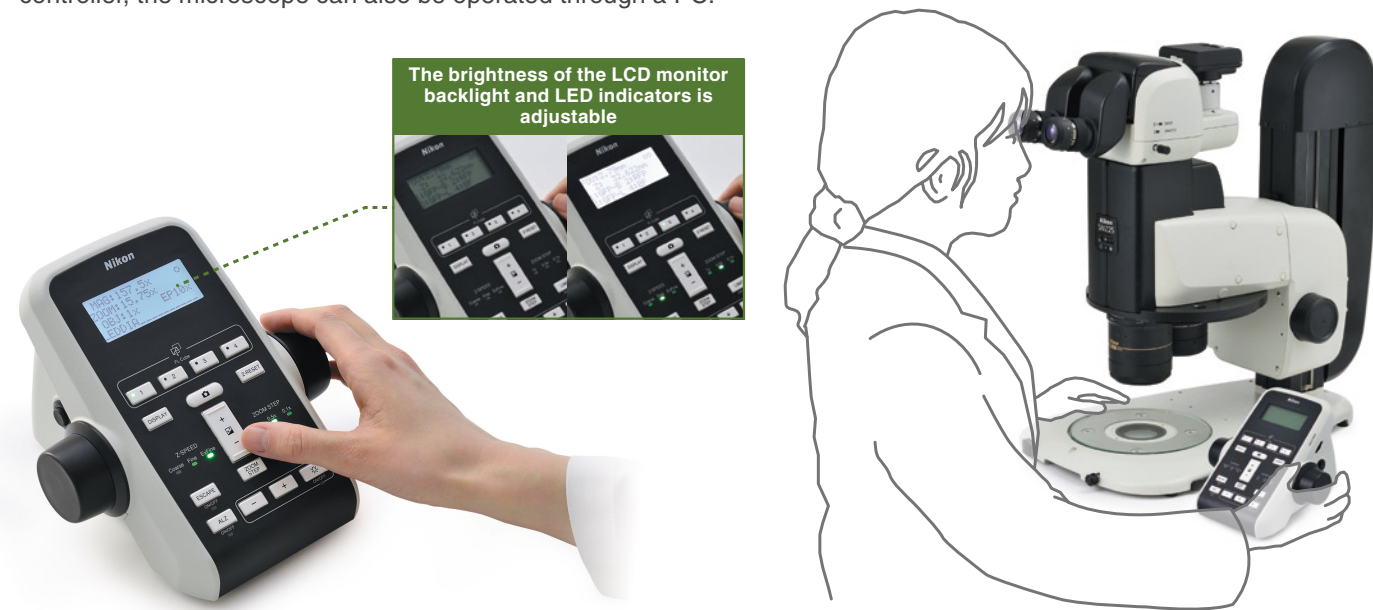

## Access the information you want quickly and easily SMZ25 SMZ18

Easily obtain the information you need, such as Z drive position, zoom factor, objective lens, filter cube, and LED DIA brightness by using the Digital Sight series and NIS-Elements or Digital Sight series DS-L3 together with the microscope.

## On-axis imaging for digital images

Easily switch between stereo position (stereoscopic view) and mono position (on-axis view) when using the P2-RN12 Intelligent Nosepiece by simply sliding the objective lens.

Digital images with uncompromised clarity can be captured using the mono position.

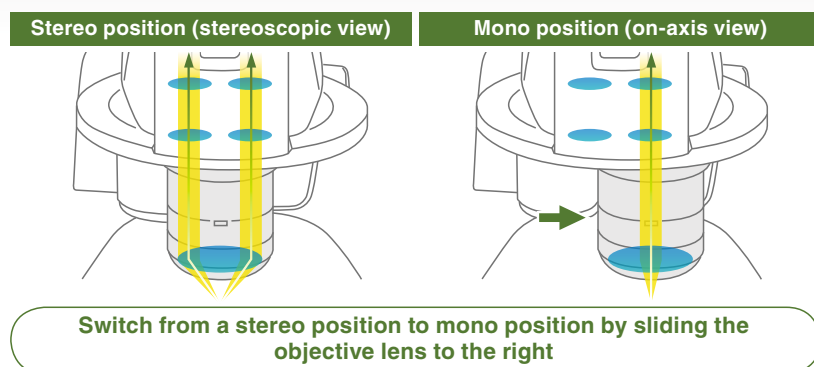

## Imaging Software NIS-Elements

One software for all systems: NIS-Elements which is Nikon's flagship, cross-platform imaging software can now be used with Nikon's latest stereomicroscope systems SMZ25 and SMZ18. NIS-Elements enables a wide range of advanced digital imaging capabilities, easily from a PC.

### Multichannel (multicolor)

Multiple fluorescent channels can be captured in conjunction with other imaging methods such as OCC or brightfield.

Individual cells resolved in a live drosophila embryo expressing GFP and mCherry (using SHR Plan Apo 2x at zoom magnification of 8x with SMZ25)  
Image courtesy of Max V. Staller, Ph.D., Clarissa Scholes, and Angela DePace, Ph.D., Harvard Medical School

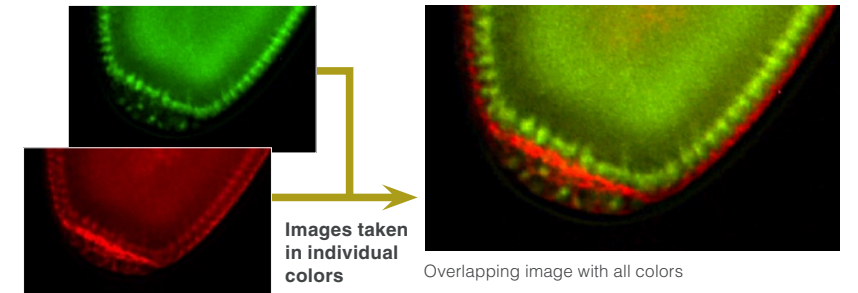

### Time lapse

Easily setup a time-lapse imaging experiment with NIS-Elements.

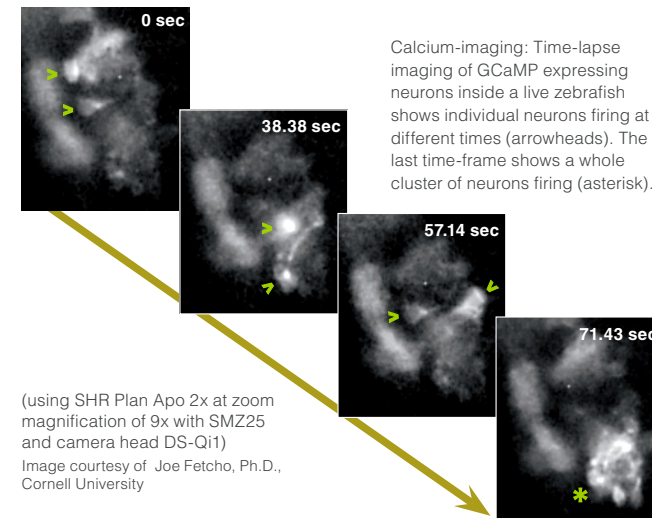

### Extended depth of focus (EDF)

Capture multiple high resolution images at different focal depths to create a single extended depth of focus image or quasi-3D image.

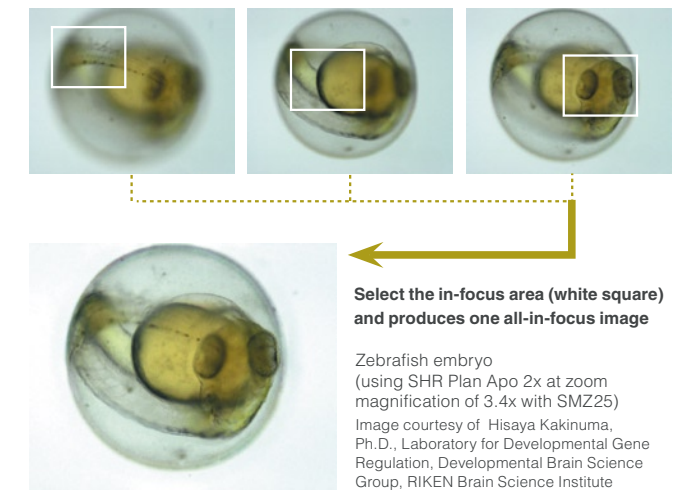

## Digital Sight Series DS-L3

DS-L3 is an easy-to-use high-definition, large touch-panel monitor that can be used to quickly capture images without a PC or monitor.

### Scale tracking

The scale bar automatically adjusts to accommodate changes in magnification.

### Scene mode

Optimal imaging parameters for each sample type and observation method can easily be set using the icons.



## Select the perfect camera for your application.

Ultra high-definition cooled color camera head  
**DS-Ri1**

- High-resolution 12.7 megapixels
- Superior color reproduction
- 10°C ambient temperature cooling

**12.7** mega-pixels  
**Color**  
**Cooled**  
**High-Resolution**



High-definition color camera head  
**DS-Fi2**

- High-resolution 5.0 megapixels
- High-speed frame rate
- Suitable for a wide range of applications

**5.0** mega-pixels  
**Color**  
**High-Resolution**



High-sensitivity cooled monochrome camera head  
**DS-Qi1**

- High sensitivity and low noise
- High quantitative capability
- Cooled 1.5-megapixel CCD

**1.5** mega-pixels  
**Cooled**



\*For more details, see the Digital Sight series catalogues.

## Wide range of available accessories

### Base unit

Nikon has improved ease of use by moving the controls to the front of the base, including the brightness adjustment dial and on/off switch.

#### Fiber DIA base

Fiber DIA base features condenser lenses that can be switched between low and high magnifications. Furthermore, the Oblique Coherent Contrast (OCC) illumination system allows high contrast illumination.

#### Slim bases

The slimmer LED DIA Base and Plain Base help increase efficiency of sample manipulation by bringing the level of the sample closer to the table.

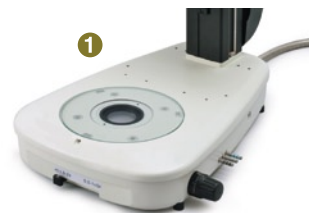

1 P2-DBF Fiber Diascopic Illumination Base

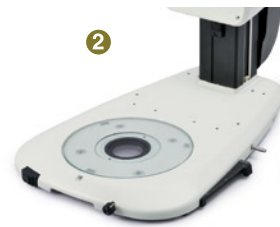

2 P2-DBL LED Diascopic Illumination Base



3 P2-PB Plain Base

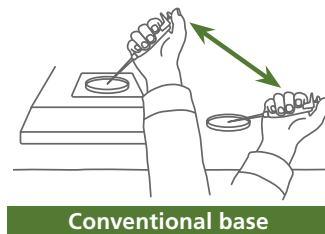

Conventional base

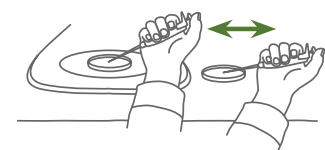

Slim base

### Example applications

#### OCC illuminator

The new LED DIA Base with a built-in OCC illuminator generates minimal heat, consumes little power and is long-life. This illuminator can enhance the contrast of uneven surfaces, such as that of an embryo.



#### Microscope-Stage Automatic Thermo Control System Thermo plate MATS

(Manufacturer: Tokai Hit Co., Ltd.)

The flat plate surface ensures easy operation of the manipulator and easy handling of specimens.



#### Conventional diascopic illumination

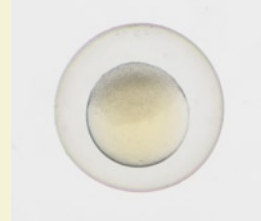

#### OCC illuminator

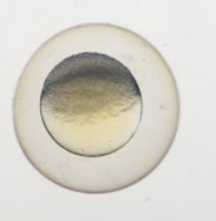

#### What is OCC illumination?

The acronym OCC stands for oblique coherent contrast (OCC), which is a form of oblique lighting method developed by Nikon. Compared to conventional diascopic illumination that illuminates directly from below, OCC illumination applies coherent light to samples in a diagonal direction, giving contrast to colorless and transparent sample structures.

Zebrafish embryo (using SHR Plan Apo 1x at zoom magnification of 5x with SMZ18)  
Image courtesy of Junichi Nakai, Ph.D. Saitama University Brain science Institute

### Focus unit

The focus unit is combined with the base unit. Choose from either a manual or motorized focus unit.



1 P2-MFU Motorized Focus Unit



2 P2-FU Focus Unit

### Stand / Focus mount SMZ18

Combine the stand with a focus mount for viewing and capturing images with reflected illumination.



1 P2-FMDN Focus Mount  
2 P-PS32 Plain Stand

### SHR Plan Apo series of Objective

The SHR Plan Apo series features higher NA, wider field of view, and superior flatness and color aberration correction. These objective lenses can be seamlessly switched because all magnifications have the same parfocal distance. The new bayonet mount design allows lenses to be safely and easily removed.



1 P2-SHR Plan Apo 0.5x  
2 P2-SHR Plan Apo 1x  
3 P2-SHR Plan Apo 1.6x  
4 P2-SHR Plan Apo 2x

		SHR Plan Apo 0.5x	SHR Plan Apo 1x	SHR Plan Apo 1.6x	SHR Plan Apo 2x
Maximum NA	SMZ25	0.078	0.156	0.25	0.321
	SMZ18	0.075	0.15	0.24	0.3
Working distance		71mm	60mm	30mm	20mm
Correction ring		—	—	—	3mm water depth
Wavelength		380-700nm			

### Tubes

Choose from two types of tilting trinocular tube and one type of low eyelevel trinocular tube. All tubes have a camera port for seamless integration with the Digital Sight series.



1 P2-TERG100 Trinocular Tilting Tube (eyepiece: port 100:0 / 0:100)  
2 P2-TERG50 Trinocular Tilting Tube (eyepiece: port 100:0/50:50)  
3 P2-TL100 Trinocular Tube L (eyepiece: port 100:0 / 0:100)

### Nosepiece / Focus mount adapter

There is the option of the nosepiece either single or double for purposes of expanding research for changing the magnification range.



1 P2-RNI2 Intelligent Nosepiece  
2 P2-FM Focus Mount Adapter

### Stage

The stage features an XY stroke of 6x4\* inches (150mm x 100mm) and can be attached to any of the bases, making it effective for capturing large images when used in combination with the imaging software NIS-Elements. A sliding stage and tilting stage are also available.

\*Limited Y travel with 32mm column bases



P-SXY64 XY Stage

### Controller

Nikon offers a remote control unit that can be used to operate the microscope and capture images by hand. A footswitch is also offered, allowing the user to operate the microscope and capture images by foot, freeing the hands for sample manipulation.



P2-RC Remote Controller

1 AZ-PCR Photo Release  
2 AZ-FSW Foot Switch



Wide range of available accessories

Epi-fluorescence light set

**Motorized epi-fluorescence light set**

The fluorescent turret can be operated using the remote control or imaging software NIS-Elements.



- 1 P2-EFLM Motorized Epi Fluorescence Attachment
- 2 Light shading Plate (comes with Fluorescence Attachment)
- 3 P2-EFL Filter Cube (GFP-B/GFP-L/RFP)
- 4 P2-EFLBF Filter Cube (Bright Field, with  $\lambda/4$  plate)
- 5 P2-CTLA Control Box
- 6 P2-RC Remote Controller



Combinations with SMZ25

**Manual epi-fluorescence light set**

An easy-to-use manual model for Nikon's newly developed high-performance epi-fluorescence attachment.



- 1 P2-EFLI Epi Fluorescence Attachment
- 2 Light shading Plate (comes with Fluorescence Attachment)
- 3 P2-EFL Filter Cube (GFP-B/GFP-L/RFP)
- 4 P2-EFLBF Filter Cube (Bright Field, with  $\lambda/4$  plate)
- 5 P2-CTLB Control Box



Combinations with SMZ18

Fiber illuminator set

**Flexible double arm fiber illumination set**

The direction and angle of illumination can be changed to suit the sample by making adjustments with these double arms. The fiber holder position can also be changed to obtain the optimal position for illuminating samples.

- 1 C-FDF Flexible Double Arm Fiber Illumination Unit
- 2 C-FIDH Fiber Holder
- 3 C-FLED2 LED Light Source for Fiber Illuminator



Combinations with SMZ18

**Ring fiber illumination set**

This ring fiber illumination set features an episcopic illumination unit that effectively captures images (can be used with 1x and 0.5x objective lenses).

- 1 P2-FIR Ring Fiber Illumination Unit
- 2 C-FLED2 LED Light Source for Fiber Illuminator



Combinations with SMZ18

Coaxial illuminator

The coaxial light illuminator makes it possible to view light reflected from the surface of a sample, which is ideal for shooting shadow-less images of thick samples.

- 1 P2-CI Coaxial Epi Illuminator
- 2 C-FLED2 LED Light Source for Fiber Illuminator



Combinations with SMZ18

Ring LED illuminator

Ring LED illuminator is equipped with high-intensity and long-life LEDs. The illuminator's dial adjusts the intensity of the white LED.

- 1 P2-FIRL LED Ring Illumination Unit



Combinations with SMZ18

Darkfield observation accessory

Darkfield viewing is possible simply by attaching the dark field unit to the base.

- 1 P-DF LED Dark Field Unit
- 2 Shading cover

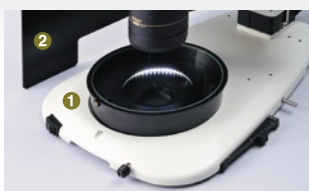

Polarizing observation accessory

The analyzer is attached to the objective and the polarizer to the base or stand to enable polarized viewing.

- 1 P2-POL Simple Polarizing Attachment

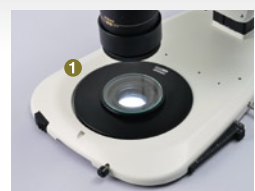

Specifications

	SMZ25	SMZ18
<b>Zooming Body</b>		
Optical system	Parallel-optics type (zooming type), apochromatic optical system	
Zoom	Motorized	Manual
Zoom ratio	25:1	18:1
Zoom range	0.63-15.75x	0.75-13.5x
Aperture diaphragm	Zooming body built-in	Zooming body built-in
<b>Objectives NA, WD (mm)</b>		
• P2-SHR Plan Apo 2x	0.312, 20 (with a correction ring for water 0 to 3mm in depth)	0.3, 20 (with a correction ring for water 0 to 3mm in depth)
• P2-SHR Plan Apo 1.6x	0.25, 30	0.24, 30
• P2-SHR Plan Apo 1x	0.156, 60	0.15, 60
• P2-SHR Plan Apo 0.5x	0.078, 71	0.075, 71
<b>Total Magnification (Using 10x eyepieces)</b>	3.15-315x (Depending on objective used)	3.75-270x (Depending on objective used)
<b>Eyepieces (F.O.V. mm)</b>	• C-W 10x (22) • C-W 15x (16) • C-W 20x (12.5) • C-W 30x (7)	
<b>Tubes (Eyepiece/Port)</b>	• P2-TERG 100 Trinocular Tilting tube (100/0 : 0/100) • P2-TERG 50 Trinocular Tilting tube (100/0 : 50/50) Inclination angle : 0-30 degree • P2-TL100 Trinocular Tube L (100/0 : 0/100) Inclination angle : 0-15 degree	
<b>Focus Unit (Stroke from Objective's parfocal point)</b>	• P2-MFU Motorized Focus Unit (Up 96mm/Down 4mm) • P2-FU Focus Unit (Up 97mm/Down 5mm)	
<b>Focus mount Adapter/Nosepiece</b>	• P2-FM Focus Mount Adapter • P2-RNI2 Intelligent Nosepiece (2 objectives can be attached)	• P2-FM Focus Mount Adapter • P2-RNI2 Intelligent Nosepiece (2 objectives can be attached) • P2-FMDN Focus Mount (for P-PS32 Plan Stand)
<b>Bases/Stand</b>	• P2-PB Plain Base • P2-DBL LED Diascopic Illumination Base (OCC illuminator built-in) • P2-DBF Fiber Diascopic Illumination Base • P-PS32 Plain Stand (Only for SMZ18)	
<b>Stages</b>	• P-SXY64 Stage • C-SSL Dia-sliding Stage • C-TRS Tilting Stage	
<b>Epi-Fluorescence Attachments</b>	4 filter cubes mountable, Fly eye lens built-in • P2-EFLM Motorized Epi Fluorescence Attachment • P2-EFLI Epi Fluorescence Attachment	
<b>Epi-Fluorescence light sources</b>	• HG Precentered Fiber illuminator Intensilight C-HGFIE HG/C-HGFI HG (130W)	
<b>Episcopic Illuminators</b>	• P2-FIRL LED Ring Illumination Unit Use with Fiber light source • P2-CI Coaxial Epi Illuminator • P2-FIR Ring Fiber Illumination Unit • C-FDF Flexible Double Arm Fiber Illumination Unit	
<b>Episcopic light sources</b>	• C-FLED2 LED Light source for fiber illuminator	
<b>Observation methods</b>	Bright Field, Epi Fluorescence, Simple Polarizing (with P2-POL Simple Polarizing Attachment), Dark Field (with P-DF LED Dark Field Unit), Oblique lighting	
<b>Weight (approx.)</b>	32kg (Motorized Epi Fluorescence Attachment configuration with Trinocular Tilting Tube, Motorized Focus Unit, Intelligent Nosepiece, LED DIA base and Objectives 1x and 0.5x)	30kg (Epi Fluorescence Attachment configuration with Trinocular Tilting Tube, Focus Unit, Intelligent Nosepiece, LED DIA base and Objectives 1x and 0.5x)
<b>Power consumption (approx.)</b>	30W (Motorized Epi Fluorescence Attachment configuration with Trinocular Tilting Tube, Motorized Focus Unit, Intelligent Nosepiece and LED DIA base)	10W (Epi Fluorescence Attachment configuration with Trinocular Tilting Tube, Focus Unit, Intelligent Nosepiece and LED DIA base)

Dimensions

SMZ25

(configured with motorized epi-fluorescence attachment and LED DIA base)

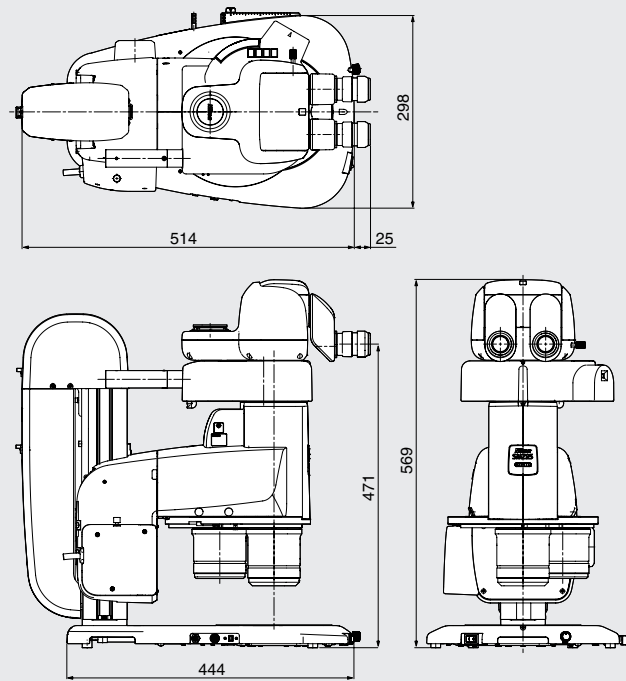

SMZ25

(configured with fiber DIA base)

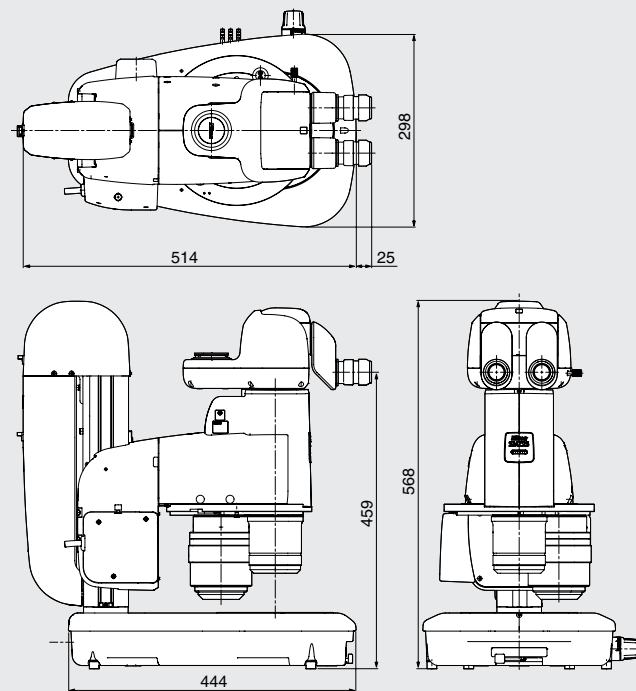

SMZ18

(configured with epi-fluorescence attachment and LED DIA base)

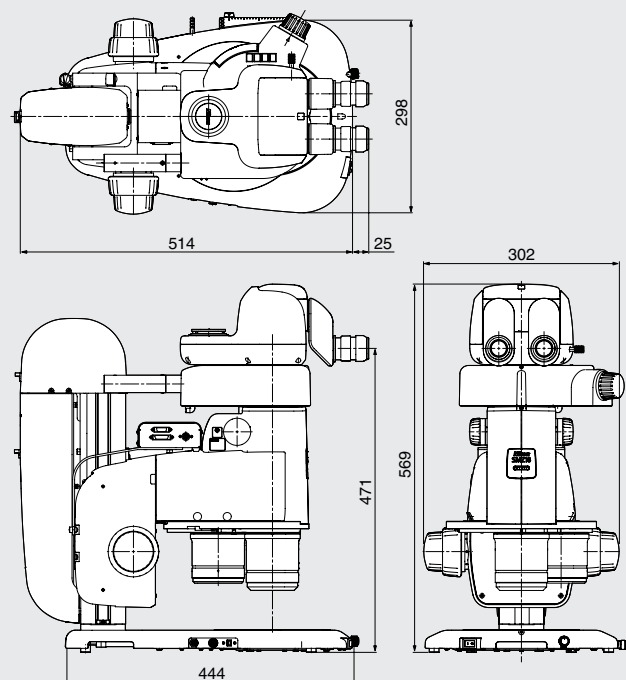

SMZ18

(configured with plain stand and focus mount)

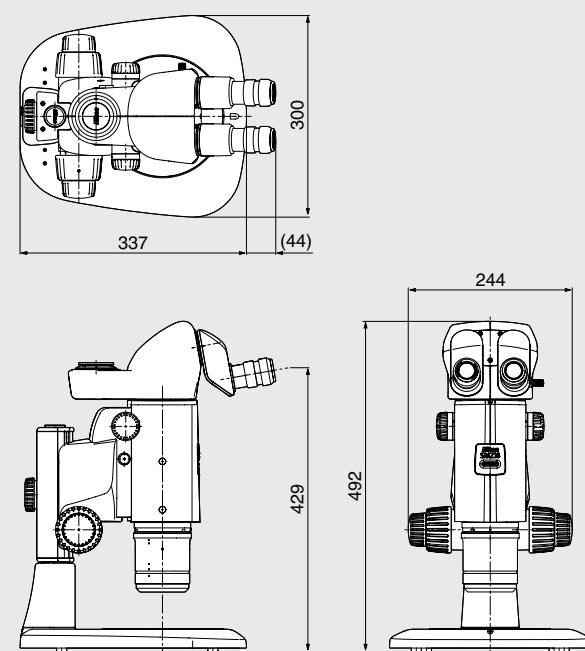

System diagram

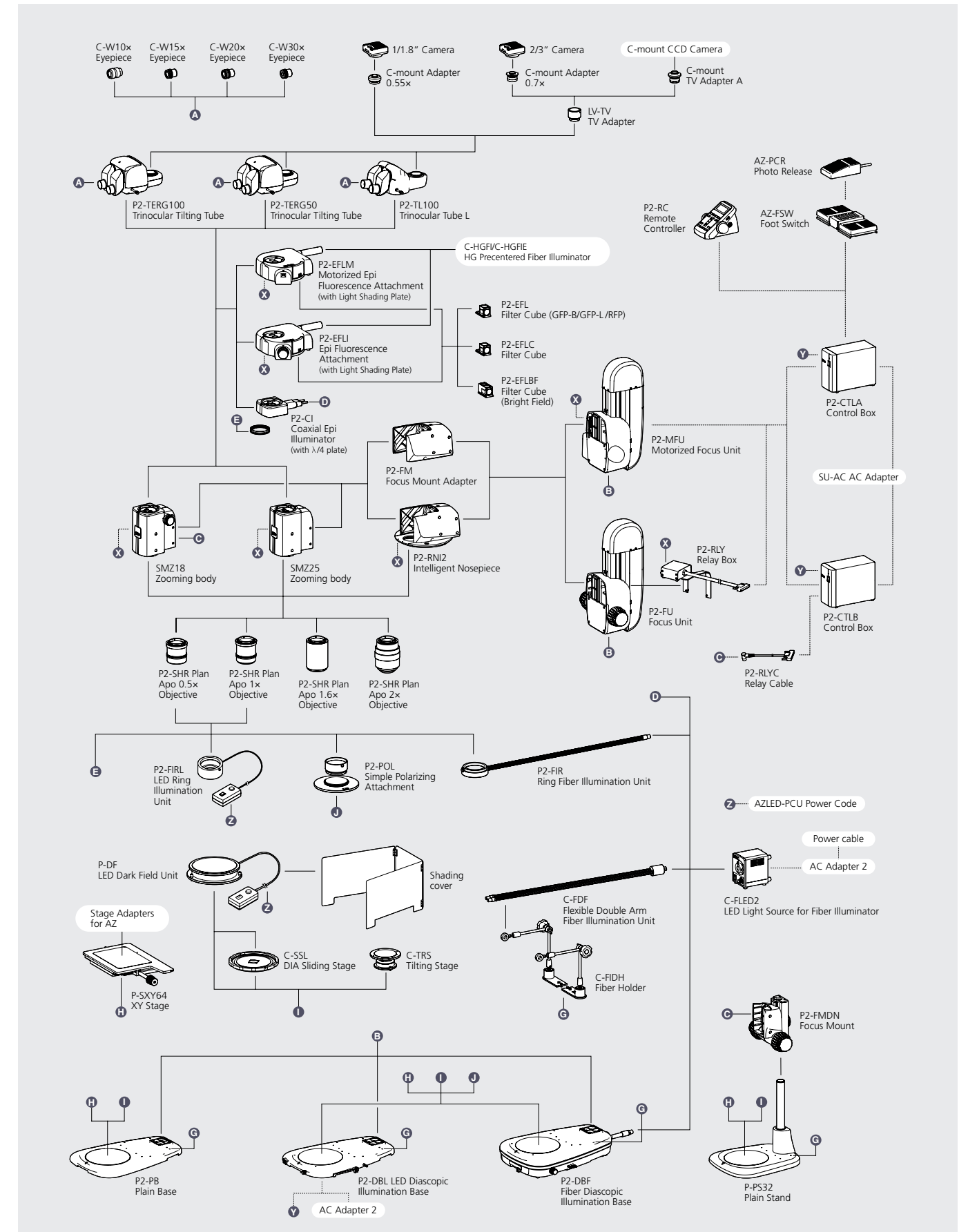



Specifications and equipment are subject to change without any notice or obligation on the part of the manufacturer. May 2013 ©2013 NIKON CORPORATION

N.B. Export of the products\* in this catalog is controlled under the Japanese Foreign Exchange and Foreign Trade Law. Appropriate export procedures shall be required in case of export from Japan.

\*Products: Hardware and its technical information (including software)



**WARNING**

TO ENSURE CORRECT USAGE, READ THE CORRESPONDING MANUALS CAREFULLY BEFORE USING THE EQUIPMENT.



**NIKON CORPORATION**

Shin-Yurakucho Bldg., 12-1, Yurakucho 1-chome  
Chiyoda-ku, Tokyo 100-8331 Japan  
Bioscience) phone:+81-3-3216-2375 fax:+81-3-3216-2385  
Industrial Instruments) phone:+81-3-3216-2384 fax:+81-3-3216-2388  
<http://www.nikon.com/instruments/>



ISO 9001 Certified  
for NIKON CORPORATION  
Instruments Company



ISO 14001 Certified  
for NIKON CORPORATION  
Yokohama Plant

**NIKON INSTRUMENTS INC.**

1300 Walt Whitman Road, Melville, N.Y. 11747-3064, U.S.A.  
phone: +1-631-547-8500; +1-800-52-NIKON (within the U.S.A. only)  
fax: +1-631-547-0306

<http://www.nikoninstruments.com/>

**NIKON METROLOGY, INC.**

12701 Grand River Avenue, Brighton, MI 48116 U.S.A.  
phone: +1-810-220-4360 fax: +1-810-220-4300

E-mail: [sales\\_us@nikonmetrology.com](mailto:sales_us@nikonmetrology.com)

<http://www.nikonmetrology.com/>

**NIKON INSTRUMENTS EUROPE B.V.**

Tripolis 100, Burgenweeshuispad 101, 1076 ER Amsterdam, The Netherlands  
phone: +31-20-7099-000 fax: +31-20-7099-298

<http://www.nikoninstruments.eu/>

**NIKON METROLOGY EUROPE NV**

Geldenaaksebaan 329, 3001 Leuven, Belgium  
phone: +32-16-74-01-00 fax: +32-16-74-01-03

Email: [sales\\_europe@nikonmetrology.com](mailto:sales_europe@nikonmetrology.com)

<http://www.nikonmetrology.com/>

**NIKON INSTRUMENTS (SHANGHAI) CO., LTD.**

CHINA phone: +86-21-6841-2050 fax: +86-21-6841-2060  
(Beijing branch) phone: +86-10-5831-2028 fax: +86-10-5831-2026  
(Guangzhou branch) phone: +86-20-3882-0550 fax: +86-20-3882-0580

**NIKON SINGAPORE PTE LTD.**

SINGAPORE phone: +65-6559-3618 fax: +65-6559-3668

**NIKON MALAYSIA SDN. BHD.**

MALAYSIA phone: +60-3-7809-3688 fax: +60-3-7809-3633

**NIKON INSTRUMENTS KOREA CO., LTD.**

KOREA phone: +82-2-2186-8400 fax: +82-2-555-4415

**NIKON INDIA PRIVATE LIMITED**

INDIA phone: +91-124-4688500 fax: +91-124-4688527

**NIKON CANADA INC.**

CANADA phone: +1-905-602-9676 fax: +1-905-602-9953

**NIKON INSTRUMENTS S.p.A.**

ITALY phone: +39-055-300-96-01 fax: +39-055-30-09-93

**NIKON AG**

SWITZERLAND phone: +41-43-277-28-67 fax: +41-43-277-28-61

**NIKON GMBH AUSTRIA**

AUSTRIA phone: +43-1-972-6111-00 fax: +43-1-972-6111-40

**NIKON BELUX**

BELGIUM phone: +32-2-705-56-65 fax: +32-2-726-66-45

**NIKON UK LTD.**

UNITED KINGDOM phone: +44-208-247-1717 fax: +44-208-541-4584

**NIKON METROLOGY UK LTD.**

UNITED KINGDOM phone: +44-1332-811-349 fax: +44-1332-639-881

E-mail: [sales\\_uk@nikonmetrology.com](mailto:sales_uk@nikonmetrology.com)

**NIKON FRANCE S.A.S.**

FRANCE phone: +33-1-4516-45-16 fax: +33-1-4516-45-55

**NIKON METROLOGY SARL**

FRANCE phone: +33-1-60-86-09-76 fax: +33-1-60-86-57-35

E-mail: [sales\\_france@nikonmetrology.com](mailto:sales_france@nikonmetrology.com)

**NIKON GMBH**

GERMANY phone: +49-211-941-42-20 fax: +49-211-941-43-22

**NIKON METROLOGY GMBH**

GERMANY phone: +49-6023-91733-0 fax: +49-6023-91733-229

E-mail: [sales\\_germany@nikonmetrology.com](mailto:sales_germany@nikonmetrology.com)